



Omnivision **VHS**

Panasonic®

TV/DVD/VCR Combination Operating Instructions

Model No. **PV-DM2792**



- Initial Setup and Connection Procedures are on pages 14 to 17.



As an **ENERGY STAR®** Partner, Matsushita Electric Corporation of America has determined that this product or product model meets the **ENERGY STAR®** guidelines for energy efficiency.

Please read these instructions carefully before attempting to connect, operate, or adjust this product. Please save this manual.
Spanish Quick Use Guide is included.
(Guía para rápida consulta en español está incluida.)

For assistance, please call : 1-800-211-PANA(7262) or send e-mail to : consumerproducts@panasonic.com

Initial Setup

Basic Operation

TV Operation

Timer Operation

Advanced Operation

For Your Information

LSQT0520A

Important Safeguards and Precautions

READ AND RETAIN ALL SAFETY AND OPERATING INSTRUCTIONS. HEED ALL WARNINGS IN THE MANUAL AND ON UNIT

INSTALLATION

1 POWER SOURCE CAUTION

Operate only from power source indicated on unit or in this manual. If uncertain, have your Electric Utility Service Company or Video Products Dealer verify your home power source.

2 POWER CORD PLUG

For safety, this unit has a polarized type plug (one wide blade), or a three-wire grounding type plug. Always hold the plug firmly and make sure your hands are dry when plugging in or unplugging the AC power cord. Regularly remove dust, dirt, etc. on the plug.

POLARIZED PLUG CAUTION:

The plug fits into outlet one way. If it cannot be fully inserted, try reversing it. If it still will not fit, have an electrician install the proper wall outlet. Do not tamper with the plug.

GROUNDING PLUG CAUTION:

The plug requires a three-hole grounding outlet. If necessary, have an electrician install the proper outlet. Do not tamper with the plug.

3 POWER CORD

To avoid unit malfunction, and to protect against electrical shock, fire or personal injury:

- Keep power cord away from heating appliances and walking traffic. Do not rest heavy objects on, or roll such objects over the power cord.
- Do not tamper with the cord in any way.
- An extension cord should have the same type plug (polarized or grounding) and must be securely connected.
- Overloaded wall outlets or extension cords is a fire hazard.

- Frayed cords, damaged plugs, and damaged or cracked wire insulation are hazardous and should be replaced by a qualified electrician.

4 DO NOT BLOCK VENTILATION HOLES

Ventilation openings in the cabinet release heat generated during operation. If blocked, heat build-up may result in a fire hazard or heat damage to cassettes or discs.

For your protection:

- Never cover ventilation slots while unit is ON, or operate unit while placed on a bed, sofa, rug, or other soft surface.
- Avoid built-in installation, such as a book case or rack, unless properly ventilated.

5 AVOID EXTREMELY HOT LOCATIONS OR SUDDEN TEMPERATURE CHANGES

Do not place unit over or near a heater or radiator, in direct sunlight, inside closed vehicles, in high temperature [over 95°F (35°C)], or in over 75% humidity. If unit is suddenly moved from a cold place to a warm one, moisture may condense in unit and on the tape causing damage. Never subject unit to vibration, impact, or place it so that the surface is tilted as internal parts may be seriously damaged.

6 TO AVOID PERSONAL INJURY

- Never place unit on support or stand that is not firm, level, and adequately strong. The unit could fall causing serious injury to a child or adult and damage to the unit.
- Move any appliance and cart combination with care.

- Quick stops, excessive force, and uneven surfaces may cause objects to overturn.
- 2** • Carefully follow all operating instructions.



OUTDOOR ANTENNA INSTALLATION

1 SAFE ANTENNA AND CABLE CONNECTION

An outside antenna or cable system must be properly grounded to provide some protection against built up static charges and voltage. Section 810

of the National Electrical Code, ANSI/NFPA 70 (in Canada, part 1 of the Canadian Electrical Code) provides information

regarding proper grounding of the mast and supporting structure, grounding of the lead-in wire to an antenna discharge unit, size of grounding conductors, location of antenna discharge unit, connection to grounding electrodes, and requirements for the grounding electrode.

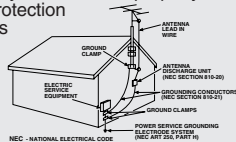

2 KEEP ANTENNA CLEAR OF HIGH VOLTAGE POWER LINES OR CIRCUITS

Locate an outside antenna system well away from power lines and electric light or power circuits so it will never touch these power sources should it ever fall. When installing antenna, absolutely never touch power lines, circuits or other power sources as this could be fatal.

USING THE UNIT

Before unit is brought out of storage or moved to a new location, refer again to the INSTALLATION section of these safeguards.

1 KEEP UNIT WELL AWAY FROM WATER OR MOISTURE

, such as vases, sinks, tubs, etc.

2 IF EXPOSED TO RAIN, MOISTURE, OR STRONG IMPACT

, unplug unit and have it inspected by a qualified service technician before use.

3 ELECTRICAL STORMS

During a lightning storm, or before leaving unit unused for extended periods of time, disconnect all equipment from the power source as well as the antenna and cable system.

4 WHEN UNIT IS PLUGGED IN

• DO NOT OPERATE IF:

- liquid has spilled into unit.
- unit was dropped or otherwise damaged.
- unit emits smoke, malodors, or noises.

Immediately unplug unit, and have it inspected by a service technician to avoid potential fire and shock hazards.

- Never drop or push any object through openings in unit.

Touching internal parts may cause electric shock or fire hazard. Do not put any foreign object on the tray.

- Keep magnetic objects, such as speakers, away from unit to avoid electrical interference.

5 USING ACCESSORIES

Use only accessories recommended by the manufacturer to avoid risk of fire, shock, or other hazards.

6 CLEANING UNIT

Unplug unit. Use a clean, dry, chemically untreated cloth to gently remove dust or debris. DO NOT USE cleaning fluids, aerosols, or forced air that could over-spray, or seep into unit and cause electrical shock. Any substance, such as wax, adhesive tape, etc. may mar the cabinet surface. Exposure to greasy, humid, or dusty areas may adversely affect internal parts.

SERVICE

1 DO NOT SERVICE PRODUCT YOURSELF

If, after carefully following detailed operating instructions, the unit does not operate properly, do not attempt to open or remove covers, or make any adjustments not described in the manual. Unplug unit and contact a qualified service technician.

2 REPLACEMENT OF PARTS

Make sure the service technician uses only parts specified by the manufacturer, or have equal safety characteristics as original parts. The use of unauthorized substitutes may result in fire, electric shock, or other hazards.

3 SAFETY CHECK AFTER SERVICING

After unit is serviced or repaired, request that a thorough safety check be done as described in the manufacturer's service literature to insure video unit is in safe operating condition.

Safety Precautions/Mesures de sécurité

Warning : To prevent fire or shock hazard, do not expose this equipment to rain or moisture.

Caution : To prevent electric shock, match wide blade of plug to wide slot, fully insert.

Avertissement : Afin de prévenir tout risque d'incendie ou de chocs électriques, ne pas exposer cet appareil à la pluie ou à une humidité excessive.

Attention : Pour éviter les chocs électriques, introduire la lame la plus large de la fiche dans la borne correspondante de la prise et pousser jusqu'au fond.

FCC WARNING : Any unauthorized changes or modifications to this equipment would void the user's authority to operate.

CAUTION:

UNIT IS A CLASS I LASER PRODUCT.

HOWEVER THIS UNIT USES A VISIBLE LASER BEAM WHICH COULD CAUSE HAZARDOUS RADIATION EXPOSURE IF DIRECTED. BE SURE TO OPERATE THE UNIT CORRECTLY AS INSTRUCTED.

WHEN THIS UNIT IS PLUGGED TO THE WALL OUTLET, DO NOT PLACE YOUR EYES CLOSE TO THE OPENING OF THE DISC TRAY AND OTHER OPENINGS TO LOOK INTO THE INSIDE OF THIS UNIT.

USE OF CONTROLS OR ADJUSTMENTS OR PERFORMANCE OF PROCEDURES OTHER THAN THOSE SPECIFIED HEREIN MAY RESULT IN HAZARDOUS RADIATION EXPOSURE.

DO NOT OPEN COVERS AND DO NOT ATTEMPT TO REPAIR THE UNIT YOURSELF. REFER SERVICING TO QUALIFIED PERSONNEL.

CAUTION:

LASER RADIATION
WHEN OPEN. DO NOT
STARE INTO BEAM.

ATTENTION:

RAYONNEMENT LASER
EN CAS D'OUVERTURE.
NE PAS REGARDER
DANS LE FAISCEAU.

(Inside of product)

FCC NOTICE:

This equipment has been tested and found to comply with part 15 of the FCC Rules. These limits are designed to provide reasonable protection against harmful interference when operated in a residential environment. If this equipment does cause interference to radio or television reception, which can be determined by turning the equipment off and on, use the equipment in another location and/or utilize an electrical outlet different from that used by the receiver. If necessary, consult the dealer or an experienced radio/TV technician for help. You may find the booklet, 'Something About Interference' available from FCC local regional offices helpful.

This product utilizes both a Cathode Ray Tube (CRT) and other components that contain lead. Disposal of these materials may be regulated in your community due to environmental considerations. For disposal or recycling information please contact your local authorities, or the Electronics Industries Alliance: <<http://www.eiae.org>>



This symbol warns the user that uninsulated voltage within the unit may have sufficient magnitude to cause electric shock. Therefore, it is dangerous to make any kind of contact with any inside part of this unit.

This symbol alerts the user that important literature concerning the operation and maintenance of this unit has been included. Therefore, it should be read carefully in order to avoid any problems.

Region Management Information

Region Management Information: This unit is designed and manufactured to respond to the Region Management Information that is recorded on a DVD disc. If the Region number described on the DVD disc does not correspond to the Region number of this unit, this unit cannot play this disc.

The Region number
for this unit is 1.



Before Using

Congratulations

on your purchase of one of the most sophisticated and reliable products on the market today. Used properly, it will bring you and your family years of enjoyment. Please fill in the information below. The serial number is on the tag located on the back of your unit.

Date of Purchase _____
Dealer Purchased From _____
Dealer Address _____
Dealer Phone No. _____
Model No. **PV-DM2792**
Serial No. _____

Accessories

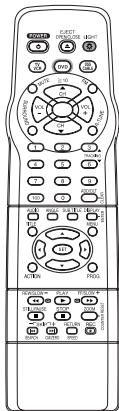

Remote Control
LSSQ0302

Batteries
2 "AA"

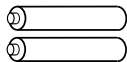

To order accessories,
call toll free 1-800-332-5368.

Loading the Batteries

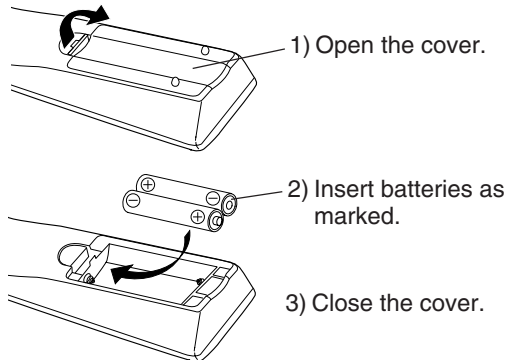

Battery replacement caution

- Do not mix old and new batteries.
- Do not mix alkaline with manganese batteries.

Prevent Accidental Tape Erasure

Break off the tab
to protect.

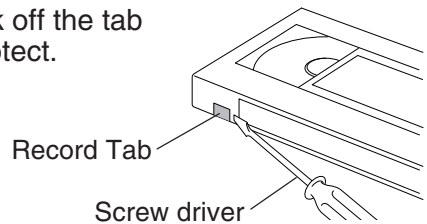

To record again.

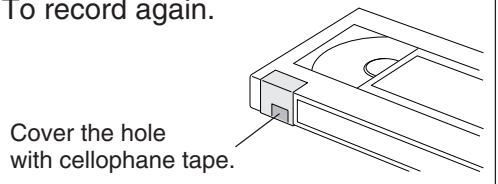

Record/Playback Time

Only use tapes with the **VHS** mark in this unit.

Tape Speed Setting	Type of Video Cassette		
	T60	T120	T160
SP (Standard Play)	1 Hour	2 Hours	2 Hours 40 Minutes
LP (Long Play)	2 Hours	4 Hours	5 Hours 20 Minutes
SLP (Super Long Play)	3 Hours	6 Hours	8 Hours

Table of Contents

Initial Setup

TV / VCR	Important Safeguards and Precautions / Safety Precautions	2 - 3
	Before Using	4
	Information (Unit, Cassette, Disc)	6 - 7
	Location of Controls	8 - 10
	Connections	11 - 13
	Initial Setup	14, 15
	Reset Language, Channels, Clock, Time Zone Adjust	16, 17

Basic Operation

TV / VCR	Playback a Tape	18
	Record On a Tape	18
	Copy Your Tapes (Dubbing)	19
DVD	Basic DVD Operation	20, 21

TV Operation

TV / VCR	TV Operation	22
	MTS Broadcast / TV Stereo System	23
	Closed Caption System	24, 25
	TV Timer Features	26
	On-Screen Display (OSD)	27
	FM Radio	28, 29

Timer Operation

TV / VCR	Timer Recording	30, 31
-----------------	-----------------------	--------

Advanced Operation

TV / VCR	Cable Box Universal Remote Control Feature	32, 33
	Tape Operation	34 - 37
	Special VCR Features	38, 39
	V-Chip Control Feature	40 - 43
	Audio Features	44, 45
	Video / Audio Menu	46
	Video / Audio Adjustment	47
DVD	Disc Operation	48 - 51
	MP3 Playback Operation	52
	DVD Operation using On-Screen Displays	53 - 55
	DVD Lock Feature	56

For Your Information

TV / VCR	Before Requesting Service	60, 61
	Warning and Instruction Displays	62
	Spanish Quick Use Guide / Guía para rápida consulta	65 - 71
	Index	72, 73
	Limited Warranty	74
	Customer Services Directory	75
DVD	Settings for DVD Operation	57 - 59
	Language Code List	63

Information (Unit, Cassette, Disc)

Head Cleaning

Playing older or damaged tapes may eventually cause video heads to become clogged.

Head Clog Sensor

During playback this screen appears if clogging is detected. To remove screen, press PLAY on the remote or unit.

V VIDEO HEADS MAY
NEED CLEANING
PLEASE INSERT HEAD
CLEANING CASSETTE
OR REFER TO MANUAL

END:PLAY

- Use “dry” type head cleaning cassette only. (Part No. NV-TCL30PT is recommended.)
- Follow cleaning tape directions carefully. Excessive use of head cleaning tape can shorten the video head life.
- If head clog symptoms persist, contact your nearest Factory Service Center or authorized Service Center. (See Page 64.)

DST (Daylight Saving Time)

Unit auto adjusts clock for DST (Daylight Saving Time.)

■ Spring (First Sunday in April)

DST : ON → Sets clock ahead one hour.

■ Autumn (Last Sunday in October)

DST : ON → Turns clock back one hour.

- If your area does not observe Daylight Saving Time, select DST : OFF (see “Clock” on pages 16 and 17).
- Keep these time changes in mind when programming the unit for timer recordings.

Features for a Quality Picture

Digital Auto Tracking

Continuously analyzes the signal and adjusts for optimum picture quality.

Manual Tracking Control (to reduce picture noise)

Use during Playback and Slow Motion mode to reduce picture noise. Press the 3 or 6 number key on the remote control or CH ▲▼ on the unit until the picture clears up. To return to Auto Tracking, press POWER off, then on again a few seconds later.

V-Lock Control

In Still mode, the 3 or 6 number key on the remote control or CH ▲▼ on the unit operate as a V-Lock control to reduce jitter.

PanaBlack™ Picture Tube

This unit uses a PanaBlack™ picture tube for better color reproduction and picture contrast.

Specifications

Display

Picture Tube: 27 inch measured diagonal 100° deflection Picture Tube

VCR

Video Recording System: 4 rotary heads helical scanning system

Audio Track: 1 track (Normal)
2 channel
(Hi-Fi Audio Sound)

Tuner

Broadcast Channels: VHF 2 ~ 13, UHF 14 ~ 69
CABLE Channels: Midband A through I (14 ~ 22)
Superband J through W (23 ~ 36)
Hyperband AA ~ EEE (37 ~ 64)
Lowband A-5 ~ A-1 (95 ~ 99)
Special CABLE channel 5A (01)
Ultraband 65 ~ 94, 100 ~ 125

FM Radio

Band range: 87.5 ~ 108.1 MHz

General

Power Source: 120V AC, 60 Hz
Power Consumption: Power On
Approx. 170 watts
Power Off
Approx. 3.5 watts

Television System: EIA Standard NTSC color
Speaker: 2 pieces
Operating Temperature: 5° C ~ 35° C (41° F ~ 95° F)
Operating Humidity: 10 % ~ 75%
Weight: 42 kg (92.4 lbs.)
Dimensions: 772 (W) x 654 (H) x 533 (D) mm
30-3/8" (W) x 25-3/4" (H) x 21" (D)

Discs played

(1) DVD-VIDEO disc
5" (12 cm) single-sided, single-layer
5" (12 cm) single-sided, double-layer
5" (12 cm) double-sided, double-layer
(one layer per side)
3" (8 cm) single-sided, single-layer
3" (8 cm) single-sided, double-layer
3" (8 cm) double-sided, double-layer
(one layer per side)
5" (12 cm) disc
3" (8 cm) disc

(2) Compact disc
(CD-DA, CD-RW, VIDEO CD)

Digital audio output:

Optical digital output:

Pickup:

Optical connector
Wave length:
655 nm (DVD)
790 nm (Video CD/CD)
Laser power: CLASS II

Note : Designs and specifications are subject to change without notice.

Disc formats supported by this unit

The unit can play back discs bearing any of the following marks:



DVD

3" (8 cm) disc / 5" (12 cm) disc



Video CD

3" (8 cm) disc / 5" (12 cm) disc



CD

3" (8 cm) disc / 5" (12 cm) disc

Discs which cannot be played with this unit

- DVD with Region No. other than "1" or "ALL"
- DVD of PAL system
- DVD-ROM
- DVD-R/DVD-RAM
- CD-ROM
- CDV
- CD-G

Do not try to play a Photo CD.



is a registered trademark.

Definition of Terms

Angle

Some DVD discs feature scenes simultaneously shot from different angles. The ANGLE button can be used to view the scene from different angles. (ANGLE Indicator lights up on the unit when a scene recorded at different angles is detected.)

Chapter Number

Titles are subdivided into numbered sections. You can quickly search for a favorite scene using these numbers.

DVD

A high-density optical disc on which high-quality pictures and sound have been digitally recorded. DVD incorporates new video compression technology (MPEG II) and high-density recording technology which allow entire movies to be recorded with incredible playback quality.

Playback Control

With Video CD (version 2.0), scenes or information may be selected for viewing or listening from an interactive menu that appears on the TV screen.

Subtitles

Written dialogue which appears at the bottom of the screen.

Time Number

The elapsed play time from the start of a disc or title. Use to quickly find scenes. (May not work with some discs.)

Title Number

For DVD discs with two or more titles, the title is numbered as title 1, title 2, etc.

Track Number

Numbers assigned to tracks on Video CDs and CDs to allow specific tracks to be quickly located.

Video CD

CD containing picture and sound with same quality level as video tape. This unit also supports Video CDs with playback control (version 2.0).

Disc Handling

Handling precautions

- Only hold disc by edges as shown. Fingerprints, dirt, and scratches can cause skipping and distortion.
- Do not write on label side of disc.
- Never use record cleaning sprays, benzine, thinner, static electricity prevention liquids, or any other solvent.
- Be careful not to drop or bend disc.
- Do not place more than 1 disc on disc tray.
- Do not try to close disc tray when disc is not properly placed.
- Always store discs in their proper cases when not in use.

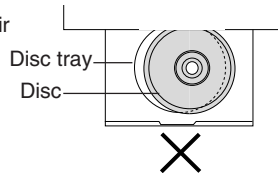
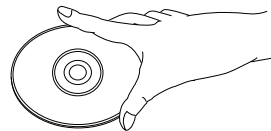

To clean disc surface

With a soft, damp (water only) cloth, gently wipe from the center hole to the outer edge as shown below. (Wiping in a circular pattern will scratch the surface.)

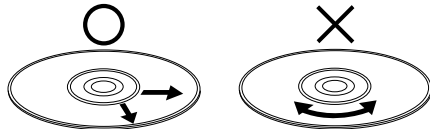

If disc is brought from a cold to a warm environment, moisture may form on the disc

Wipe away moisture with a soft, dry, lint-free cloth before using disc. (See above.)

Improper disc storage

Discs could be damaged if stored or left in areas:

- exposed to direct sunlight.
- that are humid or dusty.
- near heat (i.e. heater, radiator, etc.).

Apparatus Claims of U.S. Patent Nos. 4,631,603, 4,577,216, and 4,819,098, licensed for limited viewing uses only.

This product incorporates copyright protection technology that is protected by method claims of certain U.S. Patents and other intellectual property rights owned by Macrovision Corporation and other rights owners. Use of this copyright protection technology must be authorized by Macrovision Corporation, and is intended for home and other limited viewing uses only unless otherwise authorized by Macrovision Corporation. Reverse engineering or disassembly is prohibited.

Location of Controls

Remote Control Buttons

EJECT/OPEN/CLOSE

See next page.

POWER

Turn the unit on or off.

TV/VCR

Sets to TV/VCR mode.

MUTE

Mutes the sound instantly.

CHANNEL UP/DOWN

Selects a channel.

SURROUND

Hears a deeper, 3-D sound effect.

NUMBER Keys

Selects a channel directly.

ANGLE

Selects the desired angle in DVD mode.

AUDIO

Selects the desired audio mode.

TITLE

Selects the desired title by number on some DVDs.

SELECT ▲▼◀▶

Control navigation around on-screen menu.

ACTION

Displays Main Menu.

SET

Sets a selected menu.

REW/SLOW-

Rewinds tape and searches reverse scene. Decreases slow motion speed in Still mode.

STILL/PAUSE

Pauses picture in Play mode and frame advance picture in Still mode.

SKIP◀◀/SEARCH

Skips back one chapter or track. Goes to previous menu screen. Goes directly to the desired recording. Locates end point of recording.

PLAY

Begins playback.

SKIP▶▶/CM SKIP/ZERO SEARCH

Skips one chapter or track. Goes to next screen. In Stop mode, goes to the counter "0:00:00". In Play mode, skips over 1 to 3 minutes of tape.

DVD

Sets to DVD mode.

LIGHT

See next page.

DSS/CABLE

Sets the remote to control some basic DDS or Cable box functions.

FM

Receives FM radio signal.

VOLUME UP/DOWN

Adjusts volume.

RAPID TUNE

Displays the last channel you were watching.

ADD/DELETE/CLEAR

Adds or deletes a channel. Cancels an item on the screen.

SUB TITLE

Selects a different subtitle language.

DISPLAY/ENTER

Displays the TV status and clock. In DVD mode, displays disc and unit information.

In DSS or CABLE mode, it may be necessary after channel selection.

MENU

Displays DVD menu.

PROGRAM

Displays SET PROGRAM screen. You can set Timer Program and On-Timer.

FF/SLOW+

Fast forwards tape and searches forward scene. Increases slow motion speed in Still mode.

ZOOM/COUNTER RESET

Enlarges specific portions of DVD picture. Resets to "0:00:00" at desired portion of tape.

REC

Records a program.

RETURN/SPEED

Returns to DVD menu screen. Selects recording speed of tape.

STOP

Stops playback.

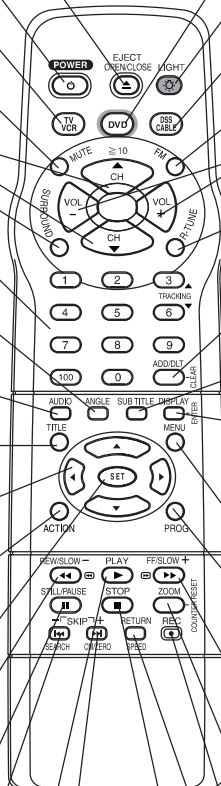

Location of Controls (continued)

Universal Light Tower® Illuminated Remote Control

LIGHT button:

When LIGHT is pressed, (DVD, $\sqrt{\text{VCR}}$, DSS/CABLE, CH UP/DOWN, VOL UP/DOWN) buttons will light for 5 seconds for easy button location.

If no button is pressed in 5 seconds, the light goes out to conserve the battery.

EJECT/OPEN/CLOSE button:

When this button is pressed in TV-VCR mode, the tape is ejected.

This button is inoperative if pressed during recording.

If pressed in DVD mode, the disc tray opens or closes.

Indicators on the Front Panel

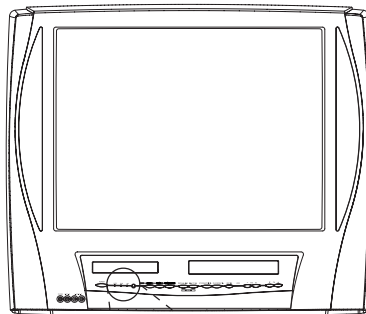

ANGLE Indicator

Lights up when a scene recorded at different angles is detected. (DVD only).
Pg. 49

PROG TIMER Indicator

Lights up when the unit is set for Timer Recording. It flashes when a Timer Recording has been set with no tape inserted, the clock is not set, or the tape is in motion.
Pg. 30
Lights up when the On Timer is set.
Pg. 26

Remote Sensor

REC Indicator

Lights up during recording. In Rec Pause or OTR Pause mode, the Indicator flashes.
Pg. 18

Front View of the unit

If the disc cannot be removed...

First, unplug unit.

Then, prepare a rigid wire (e.g. an extended paper clip) and, applying moderate force, insert it straight into the hole at the base of the tray. The tray will eject a little. Now, pull the tray all the way out and remove the disc.

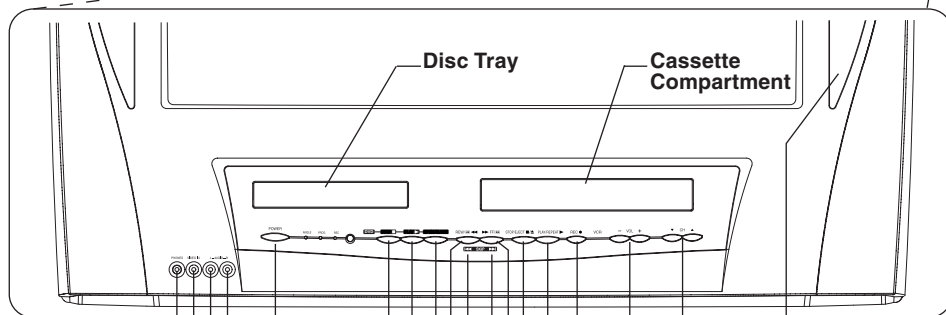
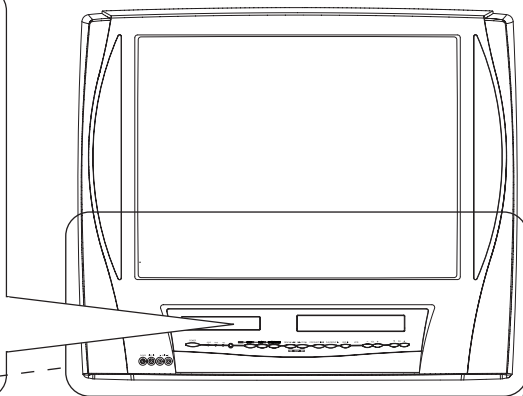
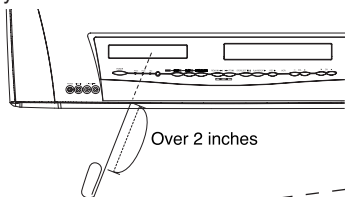

PHONES

Connect an earphone or headphones.

AUDIO/VIDEO IN Connector

Connect from other component.

POWER (See page 8.)

STOP (See page 8.)

PLAY (See page 8.)

OPEN/CLOSE (See page 8.)

REWIND/SEARCH (See page 8.)

SKIP◀ (See page 8.)

SKIP▶ (See page 8.)

Built-In SpeakerX2

CHANNEL UP/DOWN

(See page 8.)

TRACKING UP/DOWN

(See page 8.)

VOLUME UP/DOWN

(See page 8.)

REC

(See page 8.)

PLAY/REPEAT

(See page 8.)

STOP/EJECT

(See page 8.)

FAST FORWARD/SEARCH

(See page 8.)

Location of Controls (continued)

Rear View of the unit

VHF/UHF Antenna Input Terminal
See below.

AC Power Plug
When plugged into an AC outlet, this unit consumes 3.5 W of electric power in OFF condition.

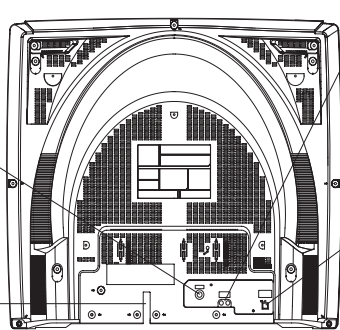

Audio Output Connector (L/R)
Pg. 12

Optical digital audio output connector
Pg. 13

Connections

For ANT./Cable

Connect the cable from Antenna/Cable to the VHF/UHF terminal on the unit.

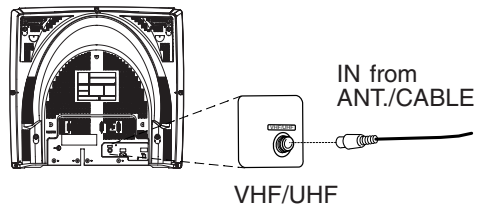

For DSS/Cable Box

Connect the OUT jack on your cable box to the VHF/UHF terminal on the unit with a RF cable.

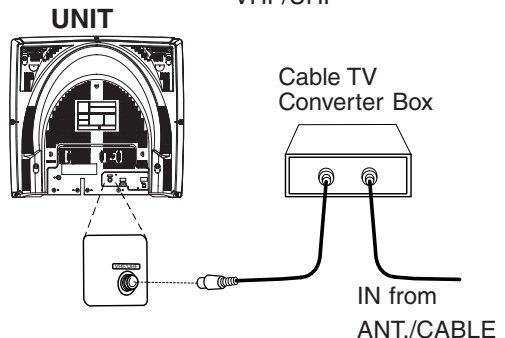

WARNING:

Overtightening "Nut type" RF coaxial cables may damage jacks. Finger tighten only.

Connections (continued)

Audio connections

■ Unit → Amplifier → Speaker

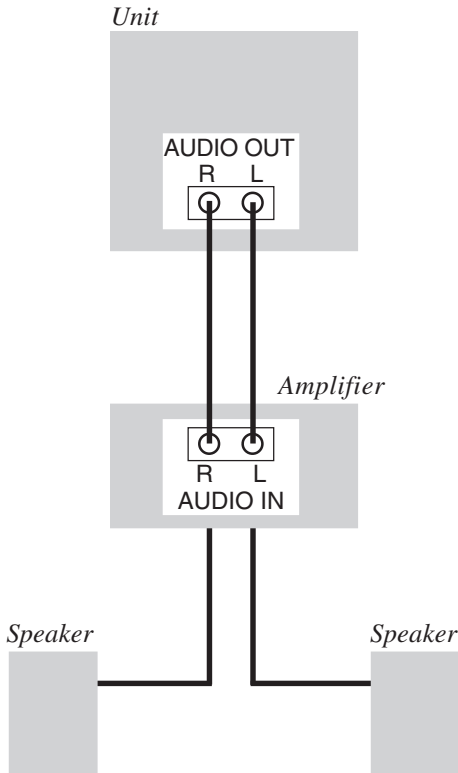

✓ Ready Checklist

- Turn down the volume, then turn this unit, as well as other equipment to be connected, off before proceeding with connection.
- Do not block ventilation holes of any of the equipment and arrange them so that air can circulate freely.
- Read through the instructions before connecting other equipment.
- Ensure that you observe the color coding when connecting audio and video cables.

Enjoying digital audio output from the digital audio output connector

Notes on audio output from the optical digital audio output connector

Disc	Sound recording format	Optical digital audio output from connector
DVD	Dolby Digital	Dolby Digital bitstream (1-5.1 ch) or OFF (no output)* ¹
	Linear PCM (48/96 kHz 16/20/24 bit) dts	Linear PCM (2ch) (48 kHz sampling/16 bit only)* ² or no output* ¹ Bitstream or no output* ¹
	Video CD	MPEG 1 PCM (44.1 kHz sampling)
CD	Linear PCM	Linear PCM (44.1 kHz sampling)

*1 The type of audio output from the connector can be selected by the Settings for DVD Operation. (See page 60.)

*2 Sound having 96 kHz sampling is converted into 48 kHz sampling when it is output from the unit's optical digital audio output connector.

For your reference:

- Dolby Digital is a digital sound compression technique developed by the Dolby Laboratories Licensing Corporation. Supporting 5.1-channel surround sound, as well as stereo (2-channel) sound, this technique enables a large quantity of sound data to be efficiently recorded on a disc.
- Linear PCM is a signal recording format used in CDs. While CDs are recorded in 44.1 kHz/16 bit, DVDs are recorded in 48 kHz/16 bit up to 96 kHz/24 bit.
- If you have a Dolby Pro Logic Surround decoder, you will obtain the full benefit of Pro Logic from the same DVD movies that provide full 5.1 channel Dolby Digital soundtracks, as well as from titles with the Dolby Surround mark. For information on Panasonic or Technics Dolby Pro Logic Surround Sound Decoders please contact your local dealer.

Manufactured under license from Dolby Laboratories. "Dolby", and the double-D symbol are trademarks of Dolby Laboratories. Confidential Unpublished Works. © 1992-1997 Dolby Laboratories, Inc. All rights reserved.

■ Unit → Decoder with Dolby Digital → Amplifier → Speaker or dts (digital theater systems)

When DVDs recorded in Dolby Digital or dts are played, Dolby Digital bitstream or dts bitstream is output from the unit Optical digital audio output connector. When the unit is connected to a Dolby Digital decoder or dts decoder, you can enjoy theater-quality audio in your home. [An optical digital audio cable (optional) is required when an optional Dolby Digital decoder or dts decoder is used.]

Notes on connecting an Optical digital audio cable (optional)

- Firmly connect the cable to the connector.

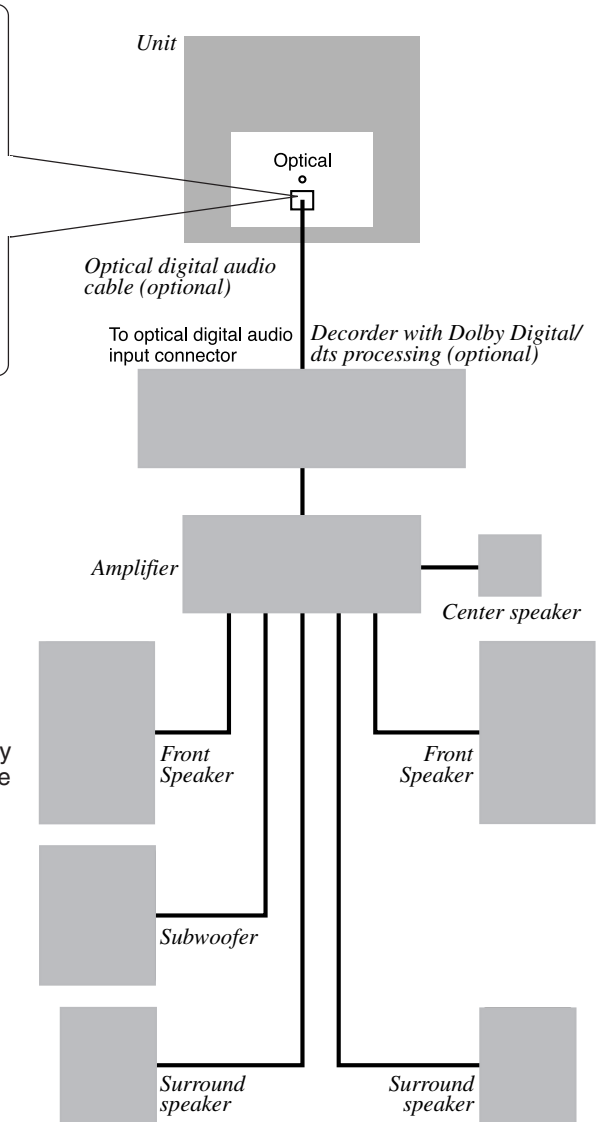
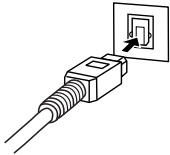

Caution for optical digital audio output connector:

- When connecting an amplifier (with an Optical digital input connector) which does not contain the Dolby Digital or dts decoder, be sure to select "OFF" at "Dolby Digital" and "OFF" at "dts" of the Settings for DVD Operation "AUDIO OUTPUT" (see page 58). Otherwise, any attempt to play DVDs may cause such a high level of noise that it may be harmful to your ears and damage your speakers.
- When a dts decoder is connected, please select "Bitstream" at "dts" of the Settings for DVD Operation "AUDIO OUTPUT". If "OFF" is selected, there will be no sound. (See page 58).
- Video CDs and CDs can be played as normal.

Note:

- Some dts decoders which do not support DVD-dts interface may not work properly with the unit.

Initial Setup (Ready to Play)

Please make all cable or antenna connections before powering on.

Initial Setup (Ready to Play)

Press **TV VCR** on the remote for TV-VCR mode.

1 Plug the unit power cord into an AC wall outlet.

2 Press **Power*** on the remote or unit. The unit comes on and auto channel and clock set starts.

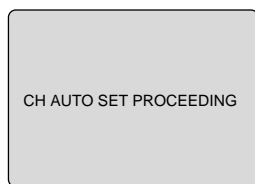

- If you use a cable box, turn it on and set it to the Public Broadcasting Service (PBS) channel in your time zone. If you use a DSS receiver, it must be turned off.



3 Settings are made automatically. When setup is done, this screen appears.

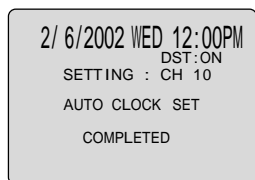

If AUTO CLOCK SET IS INCOMPLETE screen appears, set the clock using MANUAL CLOCK SET procedure on next page.

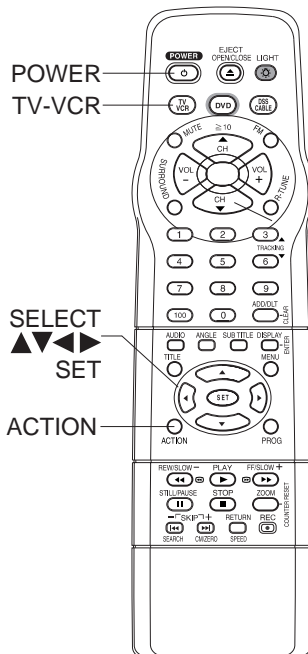
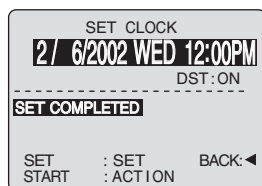

Important: If a remote control button does not work when pressed, press the TV_{VCR} button on the remote and try the button again.

Manual Clock Set

IF AUTO CLOCK SET was incomplete, manually set the clock as follows.

Press **ACTION** on the Remote to display SET CLOCK Menu screen.

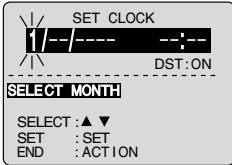

Press **▲ ▼** to select the month and press **SET** to set. In the same manner, select and set the date, year, time, and DST. (Daylight Saving Time)

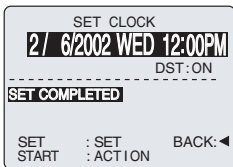

Press **ACTION** twice to start CLOCK and exit.

Reset all unit Memory Functions

When moving unit to a new location, or if a mistake was made in the Initial Setup section.

- Make sure a tape is not inserted in the unit.

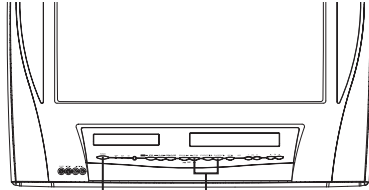

- 1 Turn the unit Power on.
- 2 Press and hold both **PLAY** and **FF** on the unit for more than 5 seconds.
 - The power will shut off.
 - Please ignore "NO CASSETTE" warning.
- 3 Do "Initial Setup" on page 14.

Initial Setup

Note to CABLE System Installer

This reminder is provided to call the CABLE (Cable TV) System Installers attention to Article 820-40 of the NEC that provides guidelines for proper grounding and, in particular, specifies that the cable ground shall be connected to the grounding system of the building, as close to the point of cable entry as practical.

Reset Language, Channels, Clock,

1

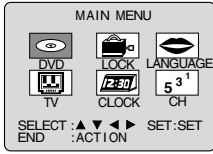

Press **ACTION***
to display MAIN MENU.

2 ■ Language

- 1) Press **▲▼◀▶** to select language icon.

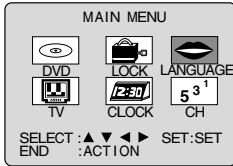

- 2) Press **SET** repeatedly.

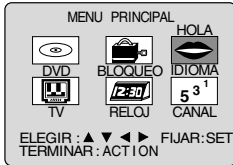

For Spanish

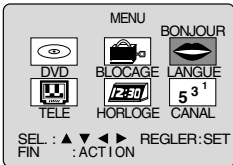

For French

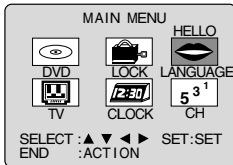

For English

- 3) Press **ACTION** to exit.

■ Channels

- 1) Press **▲▼◀▶** to select "CH."

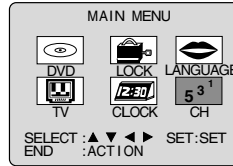

- 2) Press **SET**.

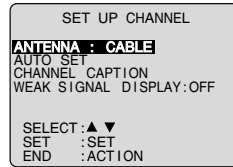

- 3) Press **▲▼** to select "ANTENNA," then press **SET** to set your antenna system ("TV" or "CABLE").

- 4) Press **▲▼** to select "AUTO SET," then press **SET**.

- After Channel Auto Set is finished, Clock Auto Set will be performed.

(If clock is set manually, Clock Auto Set will not be performed.)

■ Clock

- 1) Press **▲▼◀▶** to select "CLOCK."

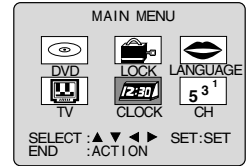

- 2) Press **SET**.

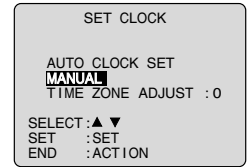

("TIME ZONE ADJUST" appears only when auto clock is set.)

- 3) Press **▲▼** to select "MANUAL," then press **SET**.

(For Auto Clock Set, select "AUTO CLOCK SET," and press **SET**.)



<Example MANUAL CLOCK SET screen>

Continued on the next page.

Time Zone Adjust

Important: If a remote control button does not work when pressed, press the TV VCR button on the remote and try the button again.

4) Press \blacktriangle \blacktriangledown and press **SET** to select and set the month, date, year, time, and DST (Daylight Saving Time).

To Make Corrections, repeatedly press \blacktriangle \blacktriangledown to move to error, then correct.

5) Press **ACTION** twice to start the clock and exit this mode.

Time Zone Adjust

(Only when Auto Clock is set.)

1) Press \blacktriangle \blacktriangledown \blacktriangleleft to select "CLOCK."

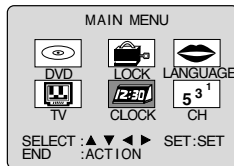

2) Press **SET**.

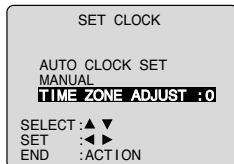

3) Press \blacktriangle \blacktriangledown to select "TIME_ZONE ADJUST" and press \blacktriangleleft or \blacktriangleright to subtract or add hour(s) as necessary.

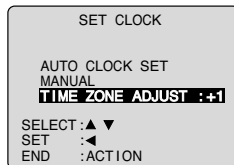

4) Press **ACTION** twice to exit.

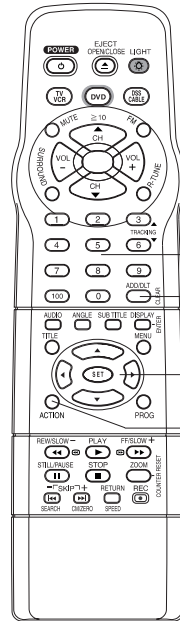

NUMBER keys

ADD/HLT

SELECT

SET

ACTION

Add or Delete a Channel

To add channel:
Select channel with **number keys** and press **ADD/HLT**.

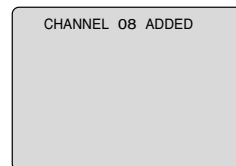

To delete channel:
Select channel with **CH▲▼** or **number keys** and press **ADD/HLT**.

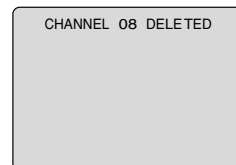

Playback a Tape

✓ Ready Checklist

- All connections are made.
- Your unit is plugged in.

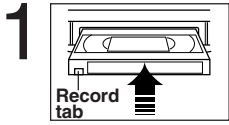

1 Insert a tape.
 • The unit power comes on automatically.

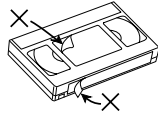

To prevent tape jam, remove loose or peeling labels from tapes.

2 Press PLAY* to play a tape.
 • If tape has no record tab (see page 4), auto play begins.

- **Forward/Reverse scene search**
 → Press **FF/SLOW+** or **REW/SLOW-**.
 → Press again or **PLAY** to release.
- **Still (Freeze) picture**
 → Press **STILL/PAUSE**.
 → Press **PLAY** to release.
- **Slow Motion picture**
 → Press **FF/SLOW+** (increases speed) or **REW/SLOW-** (decreases speed) in Still mode.
 → Press **PLAY** to release.
- **Frame by Frame picture**
 → Press **STILL/PAUSE** in Still mode.
 → Press **PLAY** to release.

Notes

- These features work best in SP or SLP mode.
- After the unit is in Still or Slow mode for 3 minutes, it will switch to Stop mode automatically to protect the tape and the video head.

- **Stop → Press STOP**
- **Rewind tape → Press REW/SLOW-** in Stop mode
- **Fast forward tape → Press FF/SLOW+** in Stop mode
- **Eject tape → Press EJECT** on the remote or **STOP/EJECT** on the unit

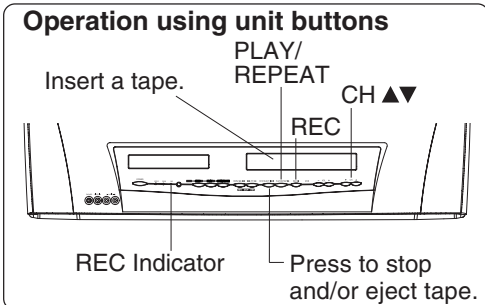

Record On a Tape

- 1 Insert a tape with record tab.**
 • The unit power comes on automatically.
- 2 Press CH ▲▼ or number keys to Select Channel.**
 • For "LINE" input, see bottom of next page.
- 3 Press SPEED** to select recording speed (see page 4).
 SP = Standard Play
 LP = Long Play
 SLP = Super Long Play
 • Selected speed is displayed.

4 Press REC to start recording.
 • To edit out unwanted portions, press **STILL/PAUSE** to pause and resume recording.
 • You cannot view another channel during recording.

- **Stop → Press STOP**
- **One Touch Recording (OTR)**
 Press **REC** repeatedly to set the recording length (30 min - 4 hours.)
 • The unit stops recording at a preset time.
 • **PROG TIMER** Indicator lights on the unit.

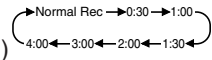

Notes

- **It is not possible to record from DVD/Video CD/CD to VHS tape using this unit.**
- After the unit has been in Rec Pause mode for 5 minutes, it will stop automatically to protect the tape and the video head.
- The remaining recording time of an OTR can be displayed by pressing **DISPLAY**.

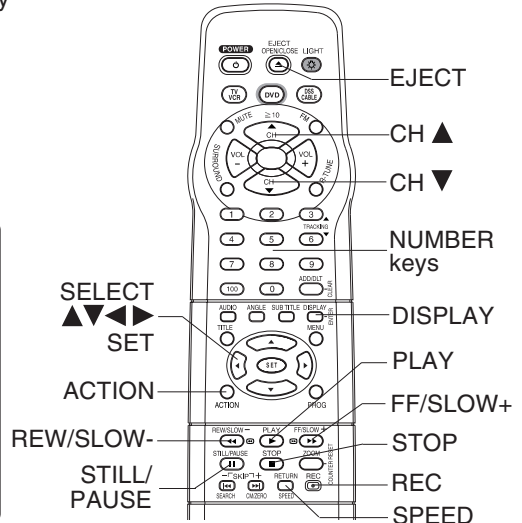

Copy Your Tapes (Dubbing)

***Important:** If a remote control button does not work when pressed, press the  button on the remote and try the button again.

Connections you'll need to make

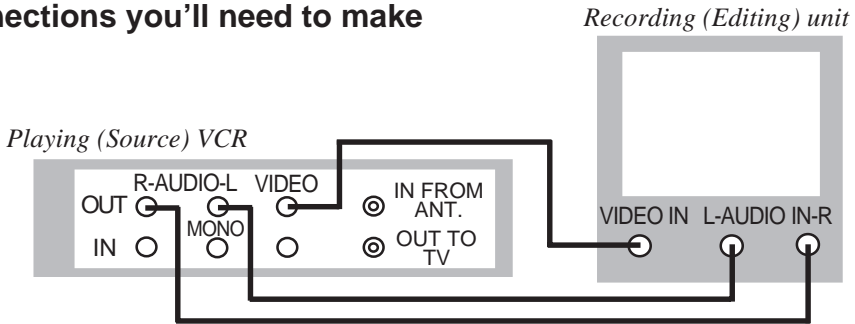

Basic Operation

Playback (Source)

Recording (Editing) unit

1  **Insert pre-recorded tape.**

 **Insert blank tape with record tab.**

- Dubbing tapes protected with Copy Guard will have poor quality results.

2 _____ **Select "LINE" mode.**
See "Selecting Input Mode" below.

3  **Press PLAY then PAUSE at starting point to put in Standby mode.**

 **Press REC, then Press STILL/PAUSE immediately to put in Standby mode.**

— (Perform operation of steps 4 and 5 on both units at same time.) —

4  **Press PLAY to start dubbing.**

 **Press STILL/PAUSE to start dubbing.**

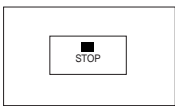
5  **Press STOP to stop dubbing.**

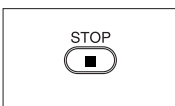
 **Press STOP to stop dubbing.**

Caution

- Unauthorized exchanging and/or copying of copyrighted recordings may be copyright infringement.
- Please note that some tapes cannot be dubbed on this unit. Also, it is not possible to dub DVD/Video CD/CD to VHS tape using this unit.

Selecting Input Mode

Method 1:
Press **CH ▲▼**. The display will change as follows.

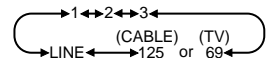

- Method 2:**
- Press **ACTION** for MAIN MENU.
 - Press **▲▼◀▶** to select "TV", then press **SET** for SET UP TV screen.
 - Press **▲▼** to select "INPUT SELECT," and then press **SET** to select "TUNER" or "LINE"
 - Press **ACTION** twice to exit this mode.

Basic DVD Operation

✓ Ready Checklist

- All connections are made. (See page 11.)
- Your unit is plugged in.
- If unit is connected to an audio amplifier, turn the stereo system's power on.

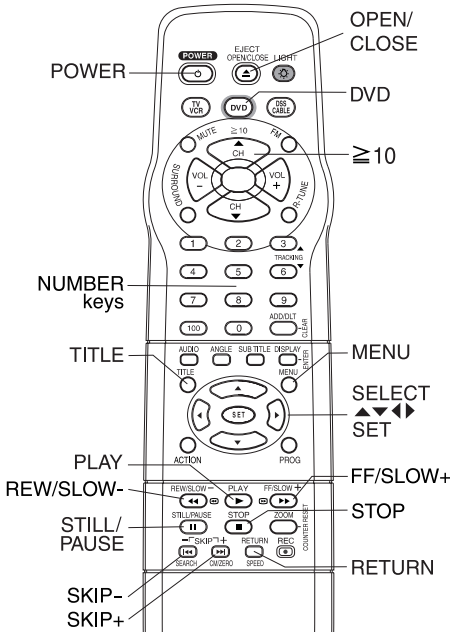

Operation using unit buttons

4 Press PLAY.

3·7
Press
OPEN/CLOSE.

1 Press
POWER

6 Press STOP.

*1 Interactive DVD...
May include multiple camera angles, stories, etc.

*2 Video CD with playback control...
Particular scenes or information can be interactively selected from a menu that appears on the screen.

1 Press **POWER*** on the remote or unit.

2 Press **DVD** to select DVD mode.
• If a disc is already inserted, go to step 4.
(Depending on the disc, playback may start automatically.)

3 Insert a disc.
1) Press **OPEN/CLOSE**.
2) Place disc into disc tray.

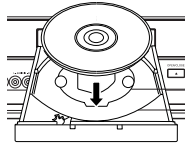

- Hold disc by its edges only (page 7) with printed side up and use guides to place into tray. Use **1** 3" (8 cm) or **2** 5" (12 cm) disc.

4 Press **PLAY** to start play.
Disc tray closes automatically.

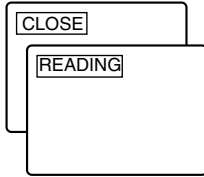

- You may also close the tray by pressing **OPEN/CLOSE**.
- Data reading time differs with each disc.

<Example>



If an interactive DVD*1 or a Video CD with playback control*2 is used and a **TITLE MENU** appears, go to step 5.

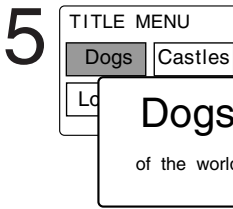

Press **▲▼◀▶** or number key(s) (see below) to select title and press **SET** to play.
Using number key(s) starts play automatically.

<Example>

- | | |
|----------------|-------------------|
| 1 digit number | 1 ●●● 1 |
| 2 digit number | 12 ●●● ≥10 1 2 |
| 3 digit number | 123 ●●● 100 1 2 3 |

Press **SKIP ▶▶|** or **◀◀** to go to next or previous menu screen.
• SKIP function not available with all discs.
Please refer to disc jacket for operation information.

To return to **MENU** (play stops)
Press **TITLE**, **MENU**, or **RETURN**. (DVD)
Press **RETURN**. (Video CD)

6 Press **STOP** to stop play.

7 Press **OPEN/CLOSE** to eject the disc.

*Important: If a remote control button does not work when pressed, press the DVD button on the remote and try the button again.

■ Forward/Reverse rapid scene search

→ Press **FF/SLOW+** or **REW/SLOW-** during play.

→ Press **PLAY** to release.

- Starting forward/reverse search during play started from menu on Video CDs may recall menu.
- Search speed, slow at first, increases with each additional press of the button up to 5 levels.

■ Forward/Reverse Chapter/Track Skip

→ Press **SKIP ►►►** or **◄◄◄** during play. Each press skips a chapter (DVD) or track (Video CD/CD).

Pressing **◄◄◄ SKIP** once midway through a chapter/track returns to start of that chapter/track. Each additional press skips back one chapter/track.

- Pressing **SKIP ►►►** or **◄◄◄** during play started from menu on Video CDs may recall menu.

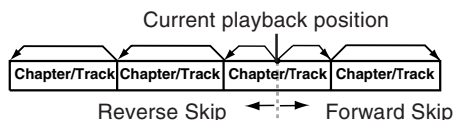

■ Still (Pause) Picture

→ Press **STILL/PAUSE** during play.

→ Press **PLAY** to release.

- **DVD/Video CD** : The unit will enter Still picture mode.
- **CD** : The unit will enter Pause mode.

■ Frame by Frame picture (DVD/Video CD)

→ Press **STILL/PAUSE** in Still mode.

→ Press **PLAY** to release.

- Each press advances picture one frame.
- Hold down for consecutive frame advance.
- Whether pictures are advanced by "FRAME" or "FIELD" is selected automatically (see page 61).

■ Slow Motion picture (DVD/Video CD)

→ Press **FF/SLOW+** or **REW/SLOW-** (DVD only) in Still mode.

→ Press **PLAY** to release.

- Slow motion speed, slow at first, is increased with each additional press of the button up to 5 levels.
- Reverse slow motion is not available for video CDs.

- When  appears on the screen while a button is being operated, it means that the corresponding operation is prohibited by the unit or the disc.

RESUME function

The unit memorizes the point where **STOP** is pressed (▶ flashes on screen).

Press **PLAY** to resume play from this point.

Pressing **STOP** again or opening the tray cancels **RESUME**, however, **RESUME** is not canceled when power is turned off and on.

- **RESUME** works only with discs for which elapsed play time is displayed during play.

Auto-Power Off function

Power turns off after unit has been in Stop mode (DVD) for about 5 minutes.

Enjoy Video CDs featuring playback control without using menus (Video CDs only)

1. Do steps 1-4 (previous page). When menu appears, press **STOP**.
2. Press number key(s) to select desired track (play begins).
 - Check disc for track numbers.
 - Press "1" to start at beginning of disc.

To Resume Menu use,

Press **STOP**, and press **PLAY**, the menu screen will be displayed.

Now, go to step 5 (previous page).

Notes

- Please read the disc jacket for operation information.
- If a single sided disc is placed in upside down, "PLEASE CHECK THE DISC, AND FOR STAINS OR SCRATCHES ON DISC" is displayed.
- Remove disc and press unit **POWER** off when not in use.
- Disc continues to rotate with menu displayed even after play is done. Press **STOP** to clear menu display when finished with menu.

TV Operation

***Important:** If a remote control button does not work when pressed, press the **VCR** button on the remote and try the button again.

1 Press **POWER*** on the remote or unit.

Ready Checklist

- All connections are made. (See page 11).
- Your unit is plugged in.

2 Use **CH ▲▼** or **number keys** to select a channel.



3 Press **VOL +** or **VOL -** to adjust volume.

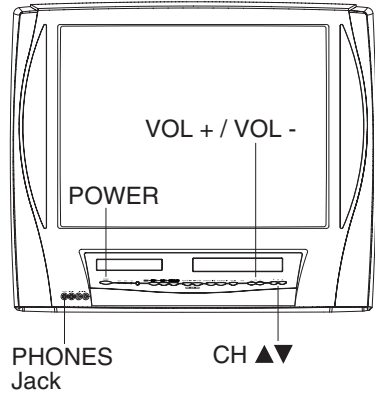

Using the 100 key

When selecting CABLE channels 100 to 125 with the number keys, first press the 100 key, and then enter the remaining two digits.

Rapid Tune

Press **R-TUNE** to display the last channel you were watching.

Audio Mute

Press **MUTE** to instantly mute the sound. Press again to restore the previous sound level.

Phones

Connect an earphone (not supplied) or headphones (not supplied) to the Phones Jack.

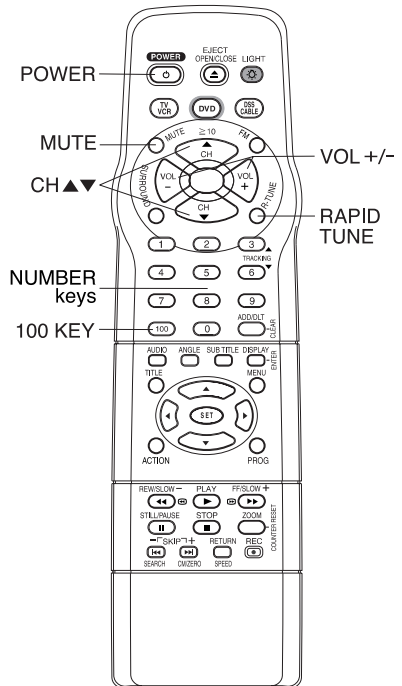

MTS Broadcast/TV Stereo System

Equipped with **dbx**[®] -TV Noise Reduction for true MTS reproduction. **dbx**[®] -TV Noise Reduction is required for good stereo separation and audio fidelity. **dbx**[®] is a registered trademark, and is licensed by **dbx**[®] Technology Licensing.

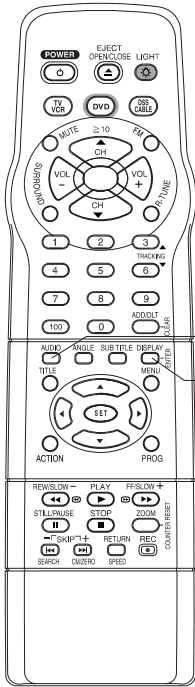

AUDIO
DISPLAY

Receivable Broadcast Types

The following are possible audio broadcast types and on-screen displays. The signal being received is indicated with an "Ⓢ" mark while the selected audio mode is indicated with an arrow. To change the audio mode for these broadcasts, see the "Select Audio Mode for TV Viewing" section (below.)

Press **DISPLAY** to display the broadcast signal being received.

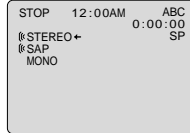

MTS Stereo and SAP broadcast

Multi-channel Television Sound Stereo (main language) and Secondary Audio Program (sub language) broadcasts are being received simultaneously. Select the STEREO or SAP audio mode.

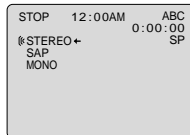

MTS Stereo broadcast

Multi-channel Television Sound Stereo broadcast. Select STEREO audio mode.
• If stereo broadcast is weak and the display flickers, select MONO audio mode for possibly better results.

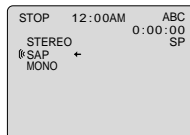

SAP broadcast

Secondary Audio Program (sub language). Select SAP audio mode for the sub language.

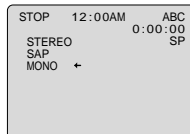

MONO broadcast

Normal monaural sound broadcast.

TV Operation

Audio Mode for TV Viewing

Press **AUDIO** to select the desired audio mode as described above.

(Arrow shows selection.)

- Each press of AUDIO will change the audio mode as shown below.
- "SAP" is selected with first press of AUDIO.

< Example >

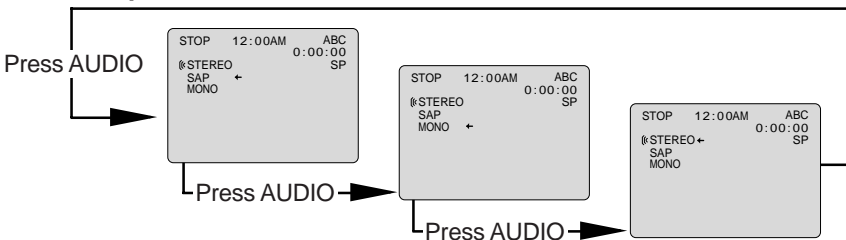

Closed Caption System

Closed Caption is ...

This multi-use system not only allows the hearing impaired to enjoy selected programs, but also makes useful information from TV stations available to everyone.

Closed Caption Mode Feature

1 Press **ACTION*** to display MAIN MENU.

2

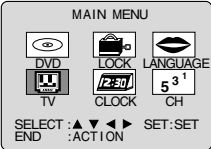

1) Press **▲▼◀▶** to select "TV."
2) Press **SET** to display SET UP TV screen.

3

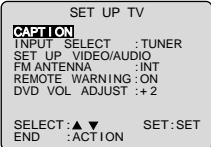

1) Press **▲▼** to select "CAPTION".
2) Press **SET** to display CAPTION screen.

4

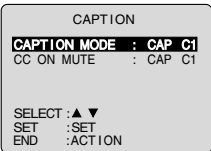

1) Press **▲▼** to select CAPTION MODE.
2) Press **SET** repeatedly to select mode. (See left.)

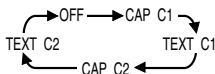

5 Press **ACTION** three times to return to the normal screen.

Recording and Playing Back a Closed Caption/Text Program

Record : Record normally. Closed Caption/Text signal, if present, is recorded automatically.

Playback : Start playback. Do above steps to select desired caption mode.

Closed Caption Mode Selections

Caption Mode: CAP C1 or C2

A narration of selected TV programs is displayed.

Check TV program listings for CC (Closed Caption) broadcasts.

Caption Mode: TEXT C1 or C2

The lower half of the screen will be blocked out. When the TV station broadcasts information, such as program listings, it will appear in this space.

Caption Mode: OFF

Closed Caption /Text narration will not be displayed.

NOTE :

The closed caption or text signal may be broadcast over C1, C2, or both.

Also, text contents can vary so you may wish to try different settings.

*Important: If a remote control button does not work when pressed, press the TV_{VCR} button on the remote and try the button again.

Caption On Mute Feature

Closed Caption narration, if available, is displayed when MUTE button is pressed for silence.

1 Press ACTION to display MAIN MENU.

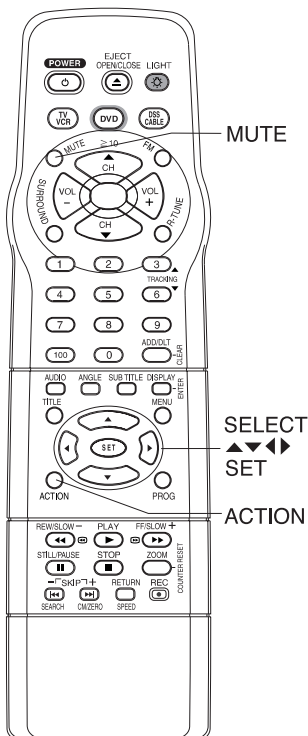

2

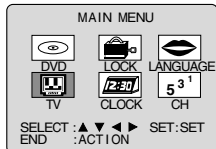

1) Press $\blacktriangle\blacktriangledown\blacktriangleleft\blacktriangleright$ to select "TV."
2) Press SET to display SET UP TV screen.

3

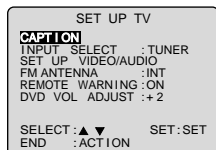

1) Press $\blacktriangle\blacktriangledown$ to select "CAPTION".
2) Press SET to display CAPTION screen.

4

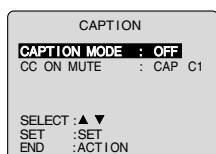

1) Press $\blacktriangle\blacktriangledown$ to select CAPTION MODE.
2) Press SET repeatedly to select "OFF."

5

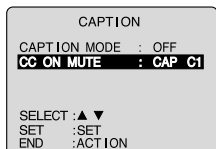

1) Press $\blacktriangle\blacktriangledown$ to select CC ON MUTE.
2) Press SET repeatedly to select desired mode.

- Each press of SET will change the display as shown left.
- The caption may be broadcast over CAP C1 or C2.

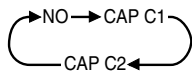

6 Press ACTION three times to return to the normal screen.

7 Press MUTE to mute the sound and display closed captioning.

- To cancel, press MUTE again.

Note

- When a disc supporting closed caption is used, the subtitle and the closed caption may overlap. In this case, turn the subtitle or caption on mute mode off. (See page 48.)

TV Timer Features

ON-TIMER with Alarm

This unit can be set to automatically power on in one of 4 modes (TV, VCR Playback, FM radio, or DVD/Video CD/CD.) You can also combine the On-Timer with a one minute alarm that gradually increases in volume.

1 Press PROG* to display SET PROGRAM screen.

2

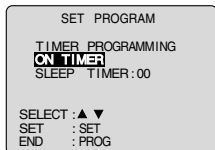

- 1) Press ▲▼ to select "ON TIMER."
- 2) Press SET to display ON TIMER screen.

3

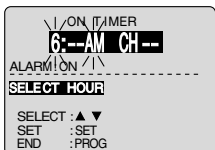

- 1) Press ▲▼ to select desired settings.
- 2) Press SET to set the ON-TIMER TIME or ON-TIMER mode.

• ON-TIMER mode selection order

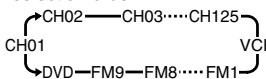

- Make sure a tape is inserted if Playback mode is selected.
- Make sure a disc is inserted if DVD (DVD/Video CD/CD) mode is selected.
- See "FM Radio" on pages 28 and 29 for instructions on how to preset FM stations.

4

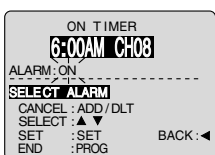

Press ▲▼ to select ALARM "ON" or "OFF."

When "ON" is selected, an alarm will gradually increase in volume for one minute or until canceled by pressing any button (including VOL + -).

To Make Corrections, use ▲▼ and ◀▶ to move back and correct.

5 Press PROG to set ON TIMER.

- "ON TIMER SET" is displayed.
- PROG-TIMER Indicator lights up on the unit.

To Cancel ON-TIMER set,

Repeat steps 1 and 2. Then, press ADD/DLT to clear the time in step 3. Now, press PROG to end. "ON TIMER END" briefly appears on-screen.

Ready Checklist

- The clock is set to correct time.

Sleep Timer

This unit can be set for auto power off.

1 Press PROG to display SET PROGRAM screen.

2

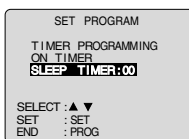

- 1) Press ▲▼ to select SLEEP TIMER.
- 2) Press SET repeatedly to select the desired time.

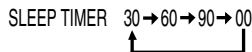

To cancel, press SET repeatedly until 00 appears.

3 Press PROG to return to the normal screen.

- Pressing DISPLAY with sleep timer set displays remaining time.

Note

If no button on the remote or unit (including a button used to turn off the alarm) is pressed within 60 minutes after unit turns itself on, it will turn itself back off.

On-Screen Display (OSD)

***Important:** If a remote control button does not work when pressed, press the **TV/VCR** button on the remote and try the button again.

TV/VCR Status & Clock Display

Press **DISPLAY** to display or remove the overlay.

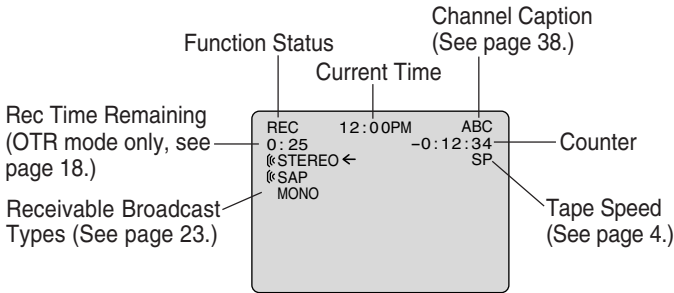

Blue Screen Display

Whenever a blank section of a tape comes up in Play mode, or when the selected channel has no broadcast signal with the Weak Signal Display Feature set to "OFF" (see page 39), the screen will turn solid blue.

Channel & Function Display

When a function button is pressed (PLAY, FF, etc.) or you change channels, the unit mode or channel number will be displayed. (Some station names may also appear if Channel Caption is set. See page 38.)

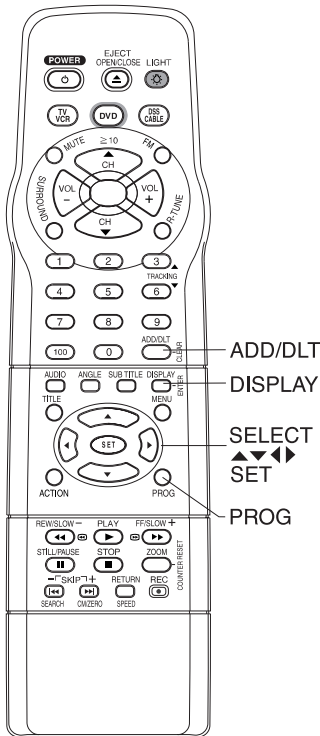
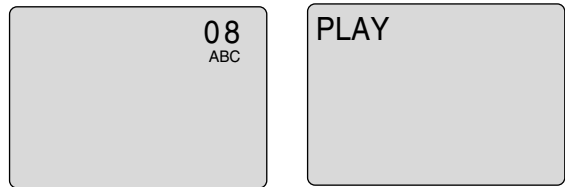

TV Operation

FM Radio

FM Radio is ...

This unit has an FM radio with built-in antenna, 9 station preset, and a band range of 87.5 ~ 108.1 MHz. You can even set the On-Timer (page 26) to wake up to your favorite radio station.

FM Radio Setup

1 Press **FM** on the remote to display FM radio mode.

2

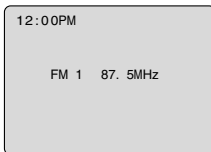

Press a number key* (1~9) to select the FM preset number.

3

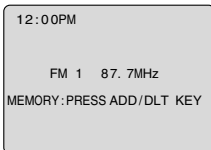

1) Press **CH ▲▼** to select the desired radio station. (Each press changes frequency 200 KHz.)

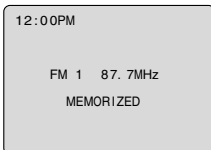

2) Press **ADD/DLT** to set the radio station.

To Make Corrections, select station with a number key, then do step 3 again.

Hold down CH ▲ or ▼ for a few seconds, then release to quickly scan for FM stations in your area.

To exit FM mode, press **TV** or **DVD** on the remote.

• To cancel, press **CH ▲ or ▼** while in search mode.

FM Antenna Setup

Make sure FM tuning is done correctly (see FM Radio Setup).

1 Press **ACTION** to display MAIN MENU.

2

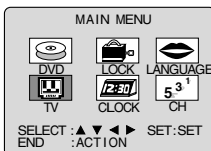

1) Press **▲▼◀▶** to select "TV."

2) Press **SET** to display SET UP TV screen.

Continued on next page.

•Important: If a remote control button does not work when pressed, press the FM button on the remote and try the button again.

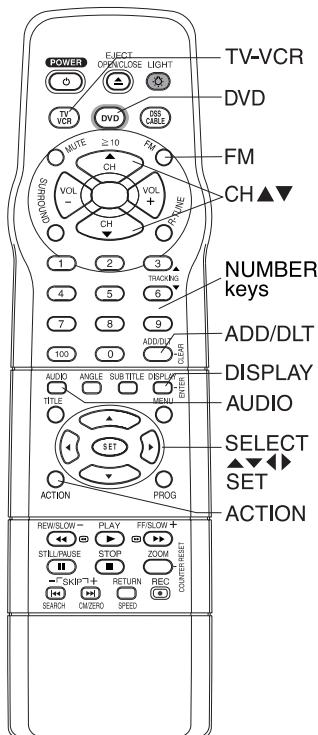

3

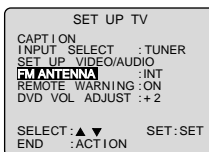

- For cable TV users
→ “INT”
- For antenna users
→ “EXT”

- 1) Press ▲▼ to select FM ANTENNA.
- 2) Press SET to select “INT (INTERNAL)” or “EXT (EXTERNAL)” whichever sounds the best.

4

Press ACTION twice to end setup.

Using FM Radio

1

Press FM on the remote to display FM radio mode.

2

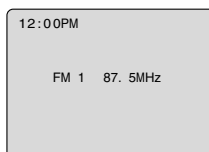

Press a number key (1~9) to select a preset FM number (see FM Radio Setup on page 28).

To exit FM mode, press TV or DVD on the remote.

Audio Mode for FM Radio

12:00PM

STEREO ←
MONO
FM 1 87.7MHz

Press AUDIO repeatedly to select “STEREO” or “MONO” in FM Radio mode.

Notes

- FM radio cannot be recorded on a Video cassette.
- You may get better reception by repositioning the unit.
- You cannot select FM Radio mode during playback or record, or while a blue back screen (PROG, ACTION, MENU) is displayed.
- Once stations are set, the selected station and current time are displayed when FM Radio mode is entered.
To remove time, press DISPLAY. If DISPLAY is pressed again, the unit status screen appears.

Timer Recording

You can set up to 8 programs to be recorded while you are away.

1 Press PROG* to display SET PROGRAM screen.

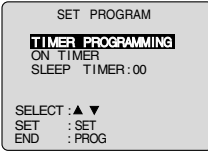

2

1) Press ▲▼ to select **TIMER PROGRAMMING**.
2) Press **SET** to display screen.

• If a program is already in memory, **press ▲▼**, and **SET** to select an unused program number.

3

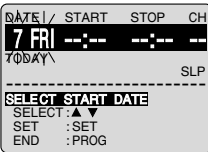

Press ▲▼ to select and **SET** or ◀▶ to set the recording **DATE**.

• 1~31 = One time
• DAILY = MON~FRI
• WEEKLY SUN~SAT
= Same time once a week

Example

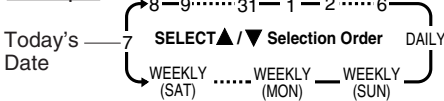

Repeat step 3 to set:

- start time, stop time
- Channel (or LINE for outside source)
- Speed (SP, LP, SLP)

4

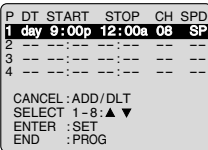

Press **PROG** to end the program.

To Enter More Programs, press ▲▼ to select and **SET** to set a blank program number, and then repeat step 3.

5

Press **PROG** twice to exit this mode.

- If you're using a cable box, make sure that it is tuned to the desired channel and the power is left on for timer recording.
- PROG TIMER Indicator lights up on the unit.

✓ Ready Checklist

- All connections are made.
- Your unit is plugged in.
- The clock is set to correct time.
- The tape is long enough.
- The record tab is in place.

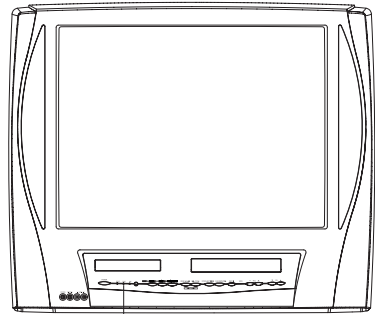

PROG TIMER Indicator

*Important: If a remote control button does not work when pressed, press the **TV/VCR** button on the remote and try the button again.

Cancel a Timer Recording: (Recording is in progress)

Hold down **STOP** for a few seconds to cancel the Timer Recording.

- Any future daily or weekly recordings will be performed as programmed.

Review, Replace or Clear Program Contents : (Recording is not in progress)

1 Repeat steps 1 and 2 on page 30.

2 Press **▲▼** to select the desired program.

P	DT	START	STOP	CH	SPD
1	day	9:00p	12:00a	08	SP
2	8	10:00a	12:00p	125	SP
3	10	8:00p	9:00p	10	SP
4	SU	9:00p	10:00p	L	LP

CANCEL : ADD/DLT
SELECT 1-8 : ▲▼
ENTER : SET
END : PROG

3 To Replace program...

DATE /	START	STOP	CH
8 SAT	9:00P	12:00A	08
7004Y\			SLP

SELECT START DATE

SELECT : ▲▼
SET : SET BACK : ◀
END : PROG

- Press **SET** to display.
- Press **▲▼** to select and press **SET** or **◀▶** to set new program contents.
- Press **PROG**.

To Clear program...

P	DT	START	STOP	CH	SPD
1					
2	8	10:00p	12:00a	125	SP
3	10	8:00p	9:00p	10	SP
4	SU	9:00p	10:00p	L	LP

SELECT 1-8 : ▲▼
ENTER : SET
END : PROG

Press **ADD/DLT**.

4 Press **PROG** twice to exit this mode.

Notes

- 2 minutes before Timer recording is performed, "PLEASE PREPARE FOR TIMER REC" appears and/or the PROG TIMER Indicator flashes. Be sure a cassette with record tab is loaded and the unit is in Stop mode.
- If the start times of two programs overlap, the lower numbered program will have priority.
- If the start time for a Timer Recording comes up during a normal recording or One Touch Recording (page 18), the Timer Recording will not be performed.
- If there is a power interruption of more than one minute, the recording may not be performed or continued.
- If "INCOMPLETE" appears after all items have been set, check all entries and make necessary corrections.

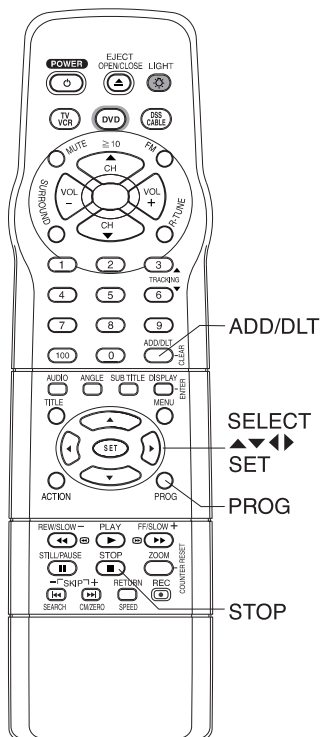

Cable Box Universal Remote Control Feature

Universal Remote Control is...

The Remote Control may be set up to control some basic DSS or Cable box functions.

The Universal Remote Control Setup

1 Find your DSS box or Cable box Brand Code Number from one of the charts on the next page.

2 Setup remote.
Hold down DSS CABLE and press number keys to enter code.

- If code number is 100 or greater, e.g., press 1 - 0 - 2 for 102.

3 Confirm code entry.
Press POWER* to turn selected unit ON or OFF.

- See below for controllable functions in each mode.

Notes

- Please repeat the Universal Remote Control Setup after replacing remote control batteries.
- The remote control will not operate all DSS receivers or Cable Boxes made by the manufactures listed. If you get no results, your particular brand cannot be controlled.

Using the Universal Remote Control (Available Buttons / Functions)

Once the remote control has been properly set up, you can select TV-VCR, FM, DVD, DSS or CABLE mode depending on which functions you wish to control.

Press ^{TV}VCR, FM, DVD or DSS CABLE on the remote control to select the desired mode. (See below for buttons available in each mode.)

Set to ^{TV}VCR, FM, DVD:

All TV functions, as well as functions of TV-VCR, FM, or DVD.

Set to DSS CABLE:

- Basic VCR functions, e.g. PLAY, REC, etc.
- CABLE/DSS function, e.g. POWER, ENTER, NUMBER keys (except 100 key), CH UP/DOWN.

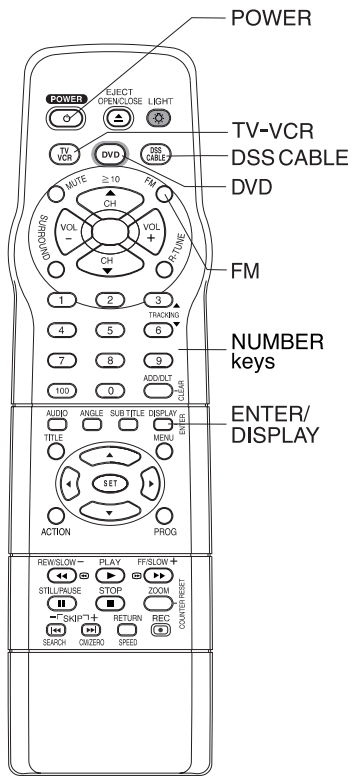

*Important: If a remote control button does not work when pressed, press the TV_{VCR} , DVD, FM button on the remote and try the button again.

DSS Brand Code Numbers

Toshiba	90	Optimus	94, 95
Hitachi/ Hughes	91, 99	Panasonic	96
Primestar	92	ProScan	97
Drake	93	RCA	97
Magnavox	94, 95	SONY	98, 105
Uniden	94, 95		

Cable Box Brand Code Numbers

Archer	44, 06, 01, 120, 05, 63, 126	Oak Sigma	46, 11, 129, 101
Cableview	29, 09, 01, 63, 120, 44, 42, 30, 52, 04, 124, 126	Panasonic	17, 16, 08, 87, 109
Citizen	44, 52, 30, 63, 42, 04, 124, 126	Philips	23, 24, 20, 13, 07, 50, 128, 129
Curtis	08, 09, 25, 61, 53, 87	Pioneer	06, 05, 12
Century	44, 51, 75, 59, 126	Pulsar	04, 42, 63, 44, 30, 52, 124, 126
Cabletenna	29, 09, 01, 63, 120, 44, 126	Quest	06, 05, 12
Cable Cinema	29, 09, 01, 63, 120, 44, 126	Radio Shack	44, 51, 75, 59, 126
Diamond	29, 09, 01, 63, 120, 44, 126	RCA	17, 16, 08, 87, 109
Eagle	62, 40, 22, 13, 58, 20, 26, 107	Realistic	44, 51, 75, 59, 126
Eastern	28, 29, 130	Recoton	44, 51, 75, 59, 126
Explorer	08, 09, 25, 61, 53, 87	Regal	41, 14, 15, 28, 102, 104, 103, 130
Gemini	30, 04, 124	Regency	28, 29, 130
General Electric	01, 57, 120	Rembrandt	44, 42, 63, 29, 01, 32, 39, 120, 126
General Instruments	01, 84, 83, 34, 03, 02, 04, 55, 65, 66, 67, 68, 120, 106, 121, 122, 115, 117, 118, 124	Samsung	42, 06, 32, 05, 40
Gerrard	44, 51, 75, 59	Scientific Atlanta	08, 09, 25, 61, 53, 87
GC Electronics	44, 42, 63, 29, 30, 52, 04, 124, 126	Sheritech	27
Hamlin	41, 14, 15, 28, 102, 104, 103, 130	Signal	26, 112
Hitachi	31	SL Marx	42, 06, 32, 40, 43, 44, 52, 63, 126
Jerrold	01, 84, 83, 34, 03, 02, 04, 55, 65, 66, 67, 68, 120, 106, 121, 122, 115, 117, 118, 124	Sprucer	17, 16, 08, 87, 109
Jasco	30, 04, 124	Standard Components	32, 39, 42, 44, 126
Macom	31	Stargate	04, 42, 32, 40, 63, 44, 30, 52, 06, 124, 126
Magnavox	26, 112	Sylvania	19, 18
Matsushita	17, 16, 08, 87, 109	Teknika	74, 35
Movietime	32, 39, 42, 44, 126, 38, 40	Telecaption	77, 127
Maestro	74, 35	Television	40, 19, 38, 32, 42, 06
NEC	40, 19, 38, 32	Texscan	19, 18
NSC	40, 19, 38, 32	Tocom	34, 33, 01, 42, 66, 120
Novavision	08, 09, 25, 61, 53, 87	Toshiba	36
Next Level	01, 84, 83, 34, 03, 02, 04, 55, 65, 66, 67, 68, 120, 106, 121, 122	Unika	44, 42, 63, 29, 01, 126, 120
Oak	46, 11, 129, 101	Universal	52, 43, 44, 63, 42, 126
		Viewstar	62, 40, 22, 13, 58, 20, 26, 107
		Videoway	07, 23, 50, 129
		Vidtek	64
		Zenith	07, 23, 50, 129

Notes

- In DSS or CABLE mode, it may be necessary to press ENTER after pressing number keys for channel selection.
- In DSS or CABLE mode, POWER, CH Up/Down, Number Keys, ACTION, PROG, DISPLAY/ENTER, SEARCH/SKIP-, R-TUNE, SELECT, SET, CM SKIP/ZERO/SKIP+, COUNTER RESET/ZOOM, ANGLE, AUDIO, TITLE, SUB TITLE, MENU, or ADD/HLT are not available. Press TV_{VCR} , FM, DVD to use these functions.
- Depending on your DSS receiver or Cable box brand, some of the functions listed may not be remote controllable.
- Some DSS receiver or Cable box brands require you to turn on the power manually.
- Due to changes in infra-red commands used by manufacturers, some brands have several codes. If your unit does not respond to the first code, please try the next one.

Advanced Operation

Tape Operation

Search System is ...

Each time a recording is made, an invisible index mark is placed on the tape. When timer recordings are made, program index and information are also included. These index marks can be used to access or scan recordings.

Index Search

Go directly to the desired recording.

1

INDEX SEARCH
ENTER INDEX NUMBER: 1
USING 1-9 KEYS

FORWARD SEARCH: FF
REVERSE SEARCH: REW
NEXT: SEARCH
EXIT: STOP

Press **SEARCH*** in Playback or Stop mode to display INDEX SEARCH screen, and then press **NUMBER** Keys to select the recording number.

- To calculate number, see below.

Press **FF** or **REW** to start search.

2

INDEX SEARCH

FORWARD SEARCH: FF
REVERSE SEARCH: REW

Play begins at search end. To search forward or back 1 index, press **FF** or **REW** while screen left in displayed (10 sec.).

To cancel, press **PLAY** or **STOP**.

■ To calculate the Index Number

Example 1:

To go to rec. 2 from rec. 4, enter 3 and press REW.

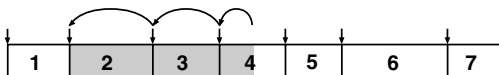

Example 2:

To go to rec. 6 from rec. 2, enter 4 and press FF.

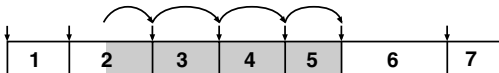

NOTE: † indicates start points of each recording.

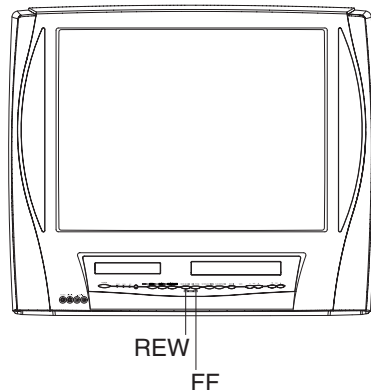

Notes

- Make each entry within 5 minutes, or the Index Search mode will be canceled.
- If Index Search is started very close to an index mark, that index mark may not be counted in the search.

•Important: If a remote control button does not work when pressed, press the $\frac{TV}{VCR}$ button on the remote and try the button again.

Program End Search

Locates end point of recording for continuity.

1 Press **SEARCH** twice in Playback or Stop mode to display PROGRAM END SEARCH screen .

2

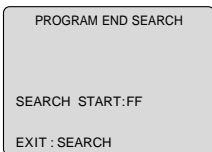

Press **FF** to start search.

To cancel, press **PLAY** or **STOP**.

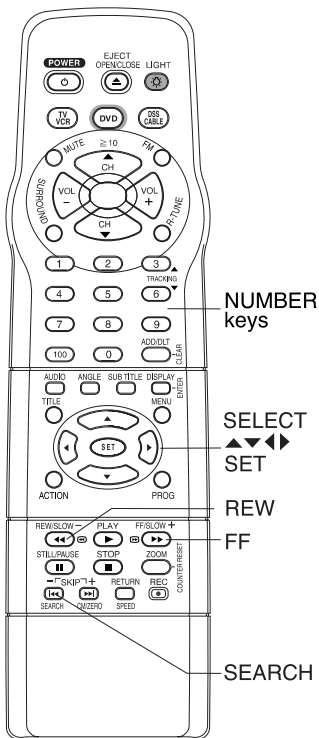

Example of Program End Search operation.

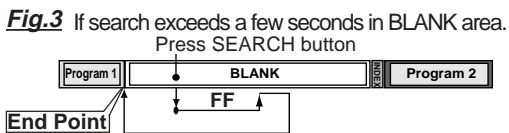
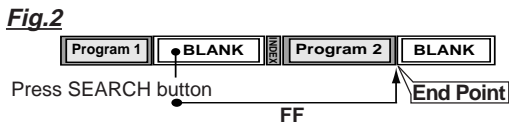
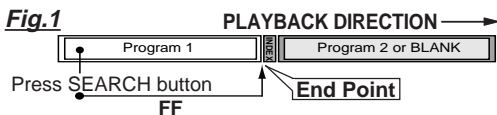

Upon locating end point...

The unit searches slightly past end point, reverse searches, and plays the last few seconds of the program, then stops.

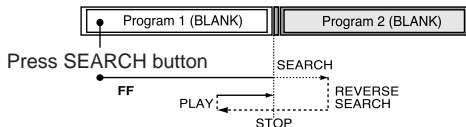

Note

- If Program End Search is started very close to an index mark, that mark may be skipped over.

Tape Operation (continued)

Repeat Play

Set to see a recording over and over.

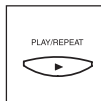
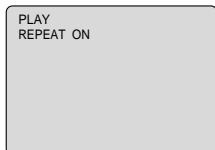

To turn "ON,"
press **PLAY/REPEAT** on the unit repeatedly in Play mode to select "REPEAT ON".

To turn "OFF,"
repeat above to select "REPEAT OFF."

- Playback repeats when tape end is reached or unrecorded portion over 30 seconds is detected.

Note

- For repeat play in DVD mode, see page 55.

Zero Search

To quickly return to a specific tape counter location.

1 Press **DISPLAY*** during playback to display the Counter.

2

A rectangular LCD display showing "PLAY 12:00 PM" on the top line and "0:00:00 SLP" on the bottom line.

Press **COUNTER RESET** at the desired position to reset to "0:00:00."

3 Continue playback, rewind, or fast forward.

4 Press **STOP**.

5 Press **CM/ZERO** in stop mode to start ZERO SEARCH.

- Unit goes into FF or REW mode and stops at the last point the Counter was set to 0:00:00.

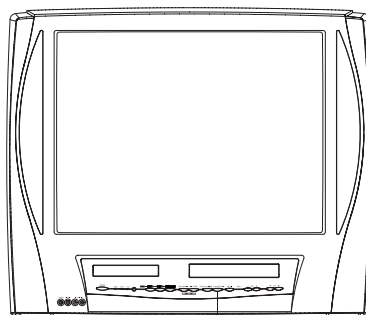

PLAY/REPEAT

*Important: If a remote control button does not work when pressed, press the TV_{VCR} button on the remote and try the button again.

Auto Operation Functions

- **Auto Shut Off**
 No broadcast signal in TV mode (Only when Weak Signal Display is set to **OFF**.), DVD stop, or blank tape is played for 5 minutes
 → Power turns off
 - This feature is canceled if any button is pressed during above conditions.
- **Auto Playback**
 Insert a tape in Power off mode
 → Power turns on
 - Playback begins if tape has no record tab.
- **Auto Rewind (except for Recording)**
 Tape reaches its end
 → Rewind, → Stop
- **Playback Auto Eject (Repeat Play is "OFF")**
 Tape with no record tab reaches its end
 → Rewind, → Stop, → Eject

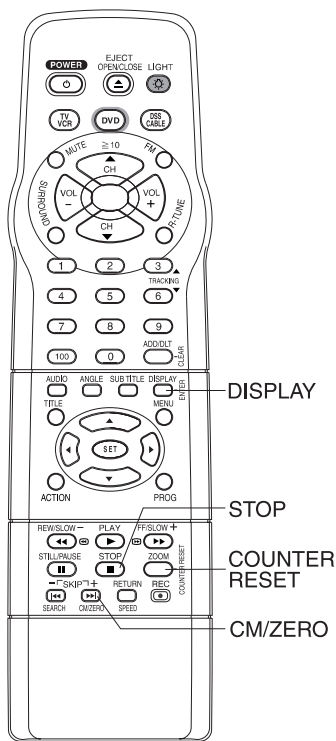

Commercial Skip

By pressing the CM/ZERO button in Playback mode you can skip over 1 to 3 minutes of recorded tape in just a few seconds.

Press CM/ZERO repeatedly to select skip time in Playback mode.

- No indication appears.

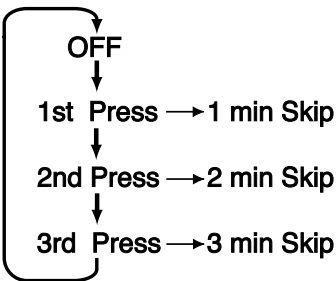

Advanced Operation

Special VCR Features

Channel Caption

1 Press **ACTION*** to display MAIN MENU.

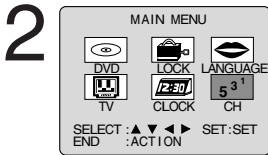

- 1) Press **▲▼◀▶** to select "CH."
- 2) Press **SET** to display SET UP CHANNEL screen.

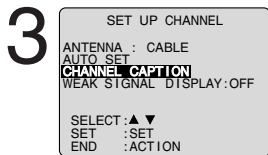

- 1) Press **▲▼** to select CHANNEL CAPTION.
- 2) Press **SET** to display screen.

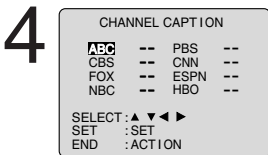

- 1) Press **▲▼** to select a station.
 - 2) Press **SET** (or **▶**) to move cursor to the right.
 - 3) Press **▲▼** to select channel number.
 - 4) Press **SET** (or **◀▶**) to set preset captions.
- Repeat step 4 until the Caption List is complete.

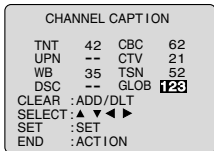

To Make Corrections

Press **▲▼**, then **SET** (or **▶**) to select channel number.
Press **▲▼** to change, or **ADD/DLT** to delete.

5 Press **ACTION** three times to end setup.

Channel Caption is ...

Station names, e.g. ABC, CNN, etc. are set so they will appear when a channel is selected. Choose 24 preset names.

Ready Checklist

- You need a list of stations and the channel numbers you receive them on.

*Important: If a remote control button does not work when pressed, press the TV_{VCR} button on the remote and try the button again.



Ready Checklist

- It is necessary to enter TV mode by pressing TV_{VCR} before selecting "CH" on the MAIN MENU.

Remote Warning Feature

When Universal Remote Control (page 32) is used, and this feature is set to "ON," a warning appears whenever an invalid key is pressed in DSS or Cable mode.

- 1 Press **ACTION** to display MAIN MENU.

2

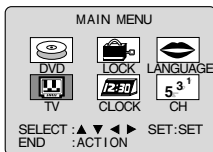

- 1) Press $\blacktriangle\blacktriangledown\blacktriangleleft\blacktriangleright$ to select "TV."
- 2) Press **SET** to display SET UP TV screen.

3

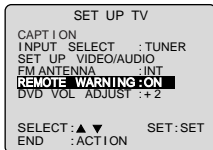

- 1) Press $\blacktriangle\blacktriangledown$ to select REMOTE WARNING.
- 2) Press **SET** to set "ON" or "OFF."

- "REMOTE WARNING : OFF"
→ Remote warning will not appear even if invalid key is pressed.

- 4 Press **ACTION** twice to return to normal screen.

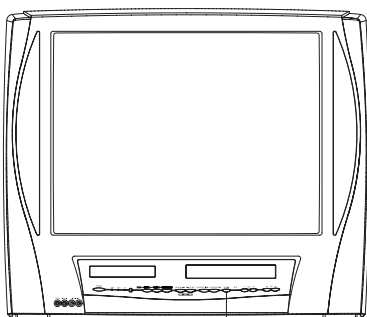

REC

Weak Signal Display Feature

When "ON" is selected, the picture is displayed even when a broadcast signal is weak or non-existent.

- 1 Press **ACTION** to display MAIN MENU.

2

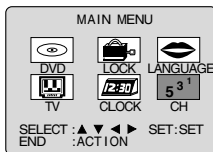

- 1) Press $\blacktriangle\blacktriangledown$ to select "CH."
- 2) Press **SET** to display SET UP CHANNEL screen.

3

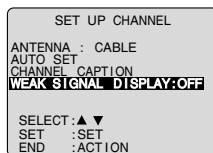

- 1) Press $\blacktriangle\blacktriangledown$ to select WEAK SIGNAL DISPLAY.
- 2) Press **SET** to set "ON" or "OFF."

Notes

- "ON" = Picture is displayed regardless of signal condition, and may not always be clearly visible.
- "OFF" = Screen turns solid blue when signal is absent or weak.
- If unit is connected to equipment which has blue back feature, selecting "ON" will have no effect on the other equipment.

- 4 Press **ACTION** twice to return to the normal screen.

VCR Lock

All operations are prohibited except Timer recording and tape eject. Useful for families with small children.

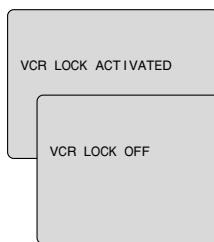

In Stop mode, **hold down REC** on the unit without a cassette inserted for 7 seconds to turn "ON." (Please ignore "NO CASSETTE" warning.)

Repeat above with or without cassette to turn "OFF."

- VCR Lock is canceled automatically after about 24 hours if clock is set.
- "Auto Power On" is not prohibited when VCR Lock is activated.

V-Chip Control Feature

V-Chip Control Feature is...

This unit has a built-in V-Chip Control which allows you to block unwanted TV usage based on US MOVIES and US TV PROGRAMS Ratings.

Process of V-Chip Control Feature



Secret Code

A 4-digit code must be entered to view a blocked program or change rating settings.

1 Press **ACTION*** to display MAIN MENU.

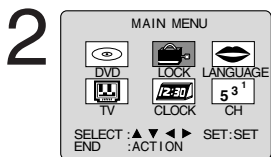

- 1) Press **▲▼◀▶** to select "LOCK."
- 2) Press **SET** to display LOCK screen.

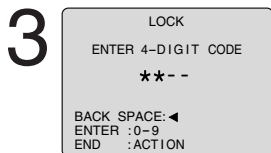

- 1) Press **number keys** to enter your secret code.
- 2) Enter **same code** again for confirmation.

To Make Corrections
Press **◀** repeatedly to move the cursor.
Press **number keys** to make the correction.

- Step 2) not necessary when changing rating or secret code.
- Take care that you are not observed entering the secret code.

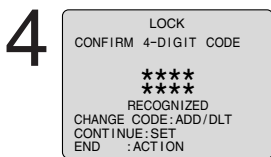

Press **SET** to display LOCK MENU (see pages 41, 42).
Or
Press **ACTION** twice to exit.

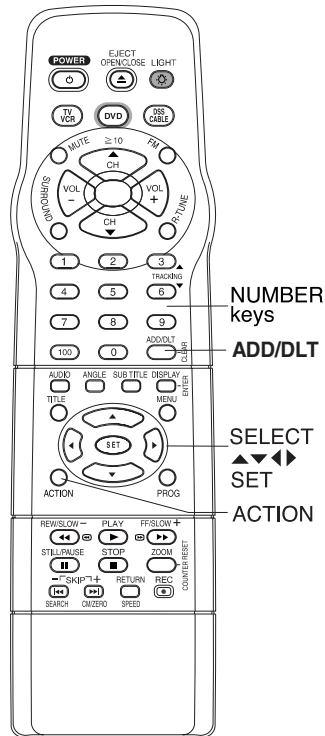

Notes

- Some rental movies do not include V-Chip data.
- DO NOT forget your secret code.
- Once ratings are set, restricted tapes or programs cannot be accessed unless the secret code is entered.

Changing your secret code

- You will need your current code.
- Do steps 1 ~ 3. In step 4, press **ADD/HLT** to clear current code.
Repeat steps 3 and 4 to enter new code.

*Important: If a remote control button does not work when pressed, press the $\frac{TV}{VCR}$ button on the remote and try the button again.

If **LOCK** menu is not displayed, do "Secret Code" steps on page 40.

US MOVIES Ratings

1

LOCK

US MOVIES :OFF

CHANGE SETTINGS

US TV PROGRAMS :OFF

CHANGE SETTINGS

DVD LOCK :OFF

CHANGE SETTINGS

NEXT PAGE

SELECT: ▲▼ SET: SET

END : ACTION

- 1) Press ▲▼ to select **US MOVIES**.
- 2) Press **SET** to set "ON" or "OFF."

- "ON" → V-Chip Control is activated.
- "OFF" → V-Chip Control is deactivated.

Note

- "NEXT PAGE" displays CANADIAN V-Chip setting menu. Not necessary except when viewing Canadian tapes or broadcasts.

2

LOCK

US MOVIES :OFF

CHANGE SETTINGS

US TV PROGRAMS :OFF

CHANGE SETTINGS

DVD LOCK :OFF

CHANGE SETTINGS

NEXT PAGE

SELECT: ▲▼ SET: SET

END : ACTION

- 1) Press ▲▼ to select **CHANGE SETTINGS**.
- 2) Press **SET** to display screen.

3

VIEW NR PROGRAMS? : YES

UNLOCKED

G

PG

PG-13

R

NC-17

X

CONTAINS NO RATING

SELECT: ▲▼ SET: SET

END : ACTION

- 1) Press ▲▼ to select **VIEW NR PROGRAMS?**.
- 2) Press **SET** to set "YES" or "NO."

NR (Not Rated) PROGRAMS

Some movies, such as old movies or foreign movies usually have no ratings.

4

VIEW NR PROGRAMS? : YES

UNLOCKED

G

PG

PG-13

R

NC-17

X

GENERAL AUDIENCE

SELECT: ▲▼ SET: SET

END : ACTION

- 1) Press ▲▼ to select and **SET** to set ratings to be blocked. (See ratings chart on this page.)

- 5** Press **ACTION** to redisplay **LOCK** menu and continue with **US TV PROGRAMS Ratings Setup** (next page). Or, press **ACTION** three times to exit.

Process of V-Chip Control Feature



US MOVIES RATINGS

G	GENERAL AUDIENCE: All ages admitted.
PG	PARENTAL GUIDANCE: Some material may not be suitable for children.
PG-13	PARENTS CAUTIONED: Some material may be inappropriate for children under 13.
R	RESTRICTED: Children under 17 must be accompanied by a parent or adult.
NC-17	OVER AGE 17 ONLY: No one 17 and under admitted.
X	ADULTS ONLY:

V-Chip Control Feature (continued)

If **LOCK** menu is not displayed, do “Secret Code” steps on page 40.

US TV PROGRAMS Ratings



- 1) Press ▲▼* to select **US TV PROGRAMS**.
- 2) Press **SET** to set “ON” or “OFF.”

- “ON” → V-Chip Control is activated.
- “OFF” → V-Chip Control is deactivated.

Note

- “NEXT PAGE” displays CANADIAN V-Chip setting menu. Not necessary except when viewing Canadian tapes or broadcasts.

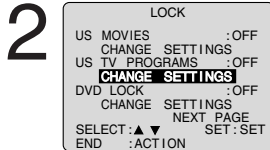

- 1) Press ▲▼ to select **CHANGE SETTINGS**.
- 2) Press **SET** to display screen.

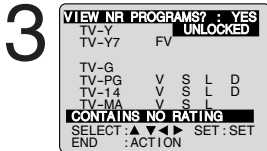

- 1) Press ▲▼ to select **VIEW NR PROGRAMS?**.
- 2) Press **SET** to set “YES” or “NO.”

NR (Not Rated) PROGRAMS

Some TV shows, such as news, sports, weather, bulletins, emergency information usually have no ratings.

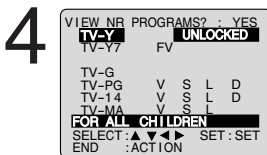

- 1) Press ▲▼ to select and **SET** to set ratings to be blocked.
(See ratings charts on this page.)

Note

You may select from standard TV ratings (chart 1), or customize to a specific content rating (chart 2).

- Ratings highlighted in Green will be blocked. Ratings in white letters will not be blocked.

- 5 Press **ACTION** four times to exit this mode.

Process of V-Chip Control Feature



US TV PROGRAMS RATINGS: Chart 1

TV-Y	FOR ALL CHILDREN: Content specifically geared to young viewers ages 2-6.
TV-Y7	FOR AGE 7 AND OLDER: May contain mild physical or comedic violence which may frighten children under 7.
TV-G	GENERAL AUDIENCE: Contains little or no violence, strong language, or sexual dialogue or situations.
TV-PG	PARENTAL GUIDANCE: May contain infrequent coarse language, limited violence, some suggestive sexual dialogue and situations.
TV-14	PARENTS CAUTIONED: May contain sophisticated themes, sexual situations, strong language, and more intense violence.
TV-MA	MATURE AUDIENCE: May contain mature themes, profane language, graphic violence, and sexual situations.

US TV PROGRAMS RATINGS: Chart 2

FV	Fantasy Violence
V	Violence
S	Sexual Situations
L	Adult Language
D	Sexually Suggestive Dialogue

*Important: If a remote control button does not work when pressed, press the **TV/VCR** button on the remote and try the button again.

Blocking Message

<When V-Chip Control is activated>

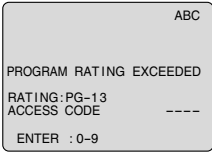

- If a program or movie exceeds the ratings you have set, a message will appear on a black background and sound is muted.

To View a Blocked Program / Movie [Temporarily Deactivate V-Chip Control]

Enter your secret code (ACCESS CODE) in the Blocking Message screen.

- V-Chip Control is reactivated when power is turned off or power failure occurs.

[Deactivate V-Chip Control]

Enter your secret code (steps 1-4 page 40). Then, set US MOVIES and/or US TV PROGRAMS to "OFF" using **▲▼** and **SET**. (Ratings set on pages 41, 42 are retained and will be in effect when V-Chip Control is activated again.)

Process of V-Chip Control Feature

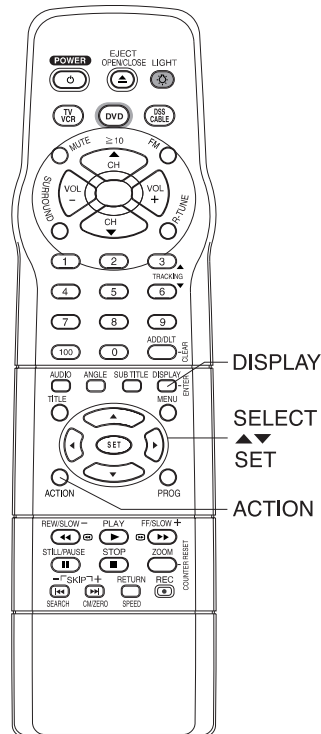

Advanced Operation

Audio Features

Audio Mode for Playback

Choose the type of sound track for playback.

1 See the “**Playback a Tape**” section on page 18 to playback the tape.

2



HIFI (L/R) ←
HIFI (L)
HIFI (R)
NORMAL

- This screen appears when you **press AUDIO** during playback.

Press AUDIO repeatedly (each press within 5 seconds) to select desired mode.

- Select “HIFI (L/R)”, “HIFI (L)” or “HIFI (R)” to listen to stereo recordings in stereo sound. Select “NORMAL” for monaural sound.

With the proper audio mode setting, your unit can:

- record and playback MTS stereo broadcast (main language) in stereo Hi-Fi. Stereo sound is recorded on the left and right audio tracks and on the video portion of a tape.
- record and playback a monaural broadcast (main language) or SAP (Secondary Audio Program, usually in a second language) on the Hi-Fi tracks for better quality monaural sound.
- playback non-Hi-Fi tapes in monaural.

Audio Mode for Recording

Choose audio mode to match recording type.

1 **Press AUDIO** repeatedly to select the audio mode according to the type of broadcast to be recorded.

- The Audio mode selected stays in effect until it is changed.

2 See the “**Record On a Tape**” section on page 18 to do a recording.

Notes

- Only tapes recorded in Hi-Fi stereo will playback with true stereo sound. Standard stereo tapes will playback with monaural sound.
- To listen to Hi-Fi stereo playback, the unit AUDIO (L/R) jacks must be connected to a stereo amp and speakers.
- There may be a difference in audio level between Hi-Fi and normal audio playback.

•Important: If a remote control button does not work when pressed, press the $\frac{TV}{VCR}$ button on the remote and try the button again.

Surround Sound System

You can hear a deeper, 3-D sound effect using just the unit's two front speakers.

Set Surround sound.

Press **SURROUND**.

•“SURROUND ON” is displayed.

To Cancel, press **SURROUND**.

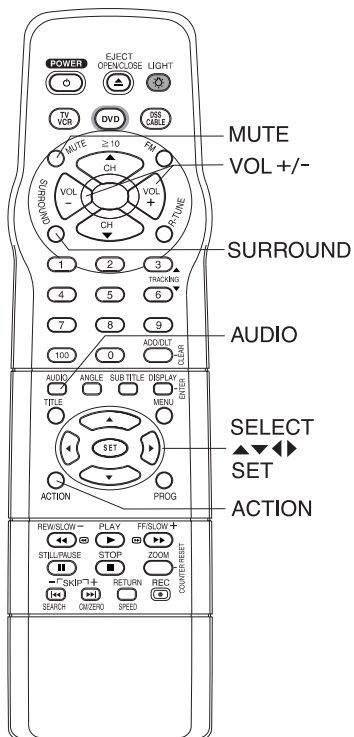
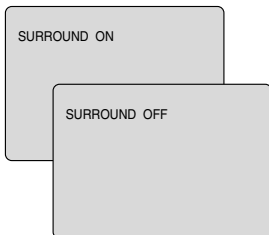

Notes

- Surround sound effect is not available for normal (mono) broadcasts.
- The surround effect (TV, VCR mode only) is not output to Audio Output L/R Connector.

Video / Audio Menu

Important: If a remote control button does not work when pressed, press the $\sqrt{\text{VCR}}$ button on the remote and try the button again.

This feature allows easy setting of picture and sound suitable for each program source.

Video Menu

1 Press **ACTION*** to display MAIN MENU.

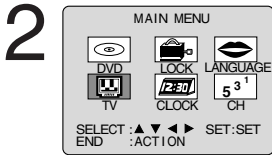

- 1) Press \blacktriangle \blacktriangledown \blacktriangleleft \blacktriangleright to select "TV."
- 2) Press **SET** to display SET UP TV screen.

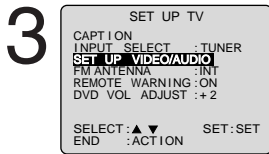

- 1) Press \blacktriangle \blacktriangledown to select "SET UP VIDEO/AUDIO."
- 2) Press **SET** to display.

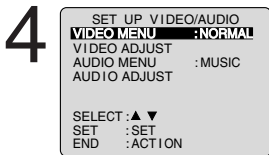

- 1) Press \blacktriangle \blacktriangledown to select "VIDEO MENU."
- 2) Press **SET** repeatedly to select desired mode. (See below.)

5 Press **ACTION** three times to end setup.

[Video Menu]

NORMAL

Factory setting.

MOVIE

Picture is adjusted for a Movie-like feel.

NIGHT

Color and picture intensity are adjusted to be easier on the eyes for night viewing.

Audio Menu

a Do steps 1 - 3 left.



- 1) Press \blacktriangle \blacktriangledown to select "AUDIO MENU."
- 2) Press **SET** to select desired mode. (See below.)

C Press **ACTION** three times to end setup.

[Audio Menu]

NORMAL

Factory setting

AUTO

[Audio AGC (Auto Gain Control)]

The sound level is automatically adjusted to suit the program source (see below left).

MOVIE

Sound suited to movies.

MUSIC

Sound suited to music.

SPEECH

Sound suited to dialog.

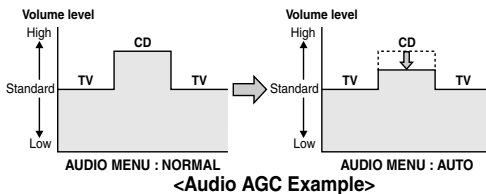
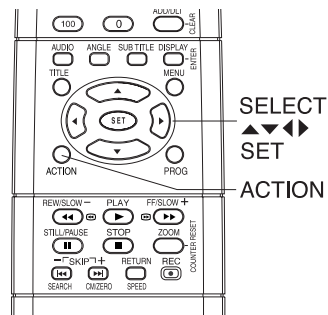

Notes

- The effects of this feature on the signal is not output to the Audio/Video Output Connector.
- When AUDIO MENU mode is "AUTO," the AUDIO ADJUST setting will be "STANDARD."
- AUDIO MENU settings remain in memory.
- VIDEO MENU settings do not remain in memory.

Video / Audio Adjustment

Video Adjustment

1 Press **ACTION** to display MAIN MENU.

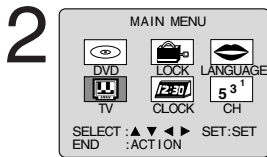

- 1) Press **▲▼◀▶** to select "TV."
- 2) Press **SET** to display SET UP TV screen.

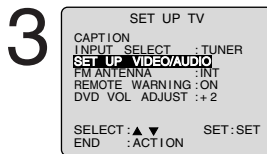

- 1) Press **▲▼** to select "SET UP VIDEO/AUDIO."
- 2) Press **SET** to display.

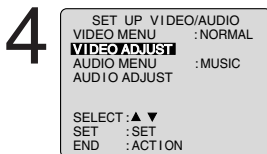

- 1) Press **▲▼** to select "VIDEO ADJUST."
- 2) Press **SET** to display.

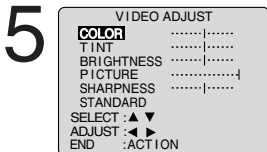

- 1) Press **▲▼** to select an item. (See below.)
- 2) Press **◀▶** to adjust.

To Reset VIDEO Controls.

Press **▲▼** and **SET** to select and set "STANDARD." All controls return to their factory settings.

6 Press **ACTION** four times to end setup.

[VIDEO Adjustment]

COLOR Control

Adjust color intensity.

TINT Control

Adjust for natural flesh tones.

BRIGHTNESS Control

Adjust picture brightness.

PICTURE Control

Adjust picture intensity by adjusting both contrast and color level in the proper balance.

SHARPNESS Control

Adjust picture sharpness.

Audio Adjustment

a Press **ACTION** to display MAIN MENU.

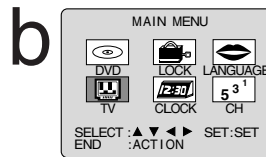

- 1) Press **▲▼◀▶** to select "TV."
- 2) Press **SET** to display SET UP TV screen.

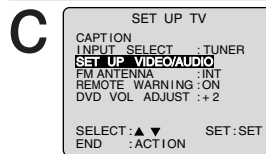

- 1) Press **▲▼** to select "SET UP VIDEO/AUDIO."
- 2) Press **SET** to display.

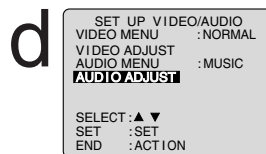

- 1) Press **▲▼** to select "AUDIO ADJUST."
- 2) Press **SET** to display.

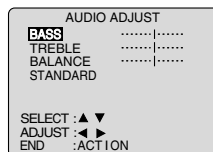

- 1) Press **▲▼** to select an item. (See below.)
- 2) Press **◀▶** to adjust.

To Reset AUDIO Controls.

Press **▲▼** and **SET** to select and set "STANDARD." All controls return to their factory settings.

f Press **ACTION** four times to end setup.

[AUDIO Adjustment]

BASS Control

To adjust the intensity of low frequency sound.

TREBLE Control

To adjust the intensity of high frequency sound.

BALANCE Control

To adjust the (L/R) unit speaker output level.

- The levels set here do not affect other audio equipment when connected to the Audio Output L/R Connector.

Disc Operation

Subtitle Language (DVD only)

You can select a different subtitle language (if offered) than the one set at the Settings for DVD Operation. (See page 57.)

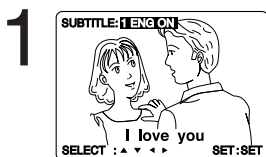

Press SUB TITLE* in Play mode to display the subtitle selection on-screen.

- Display disappears after 5 seconds.
- When no subtitles are offered, “-” will be displayed instead of the language number.



- 1) Press ▲▼ to select desired language.
- 2) Press ► (or ◀) to set.
- 3) Press ▲ (or ▼) to select “ON” or “OFF.”

Number of subtitle language being played back.

Notes

- When closed captioning is used along with subtitles, they may overlap. If so, turn one function off. (See pages 24 and 25.)
- If after several presses of the button the language does not change, language selection is not offered on the disc.
- Subtitles may not change to the selected language immediately.
- When power is turned on again or disc is removed, subtitles revert to initial setting language. If the initial language is not recorded on the disc, the disc’s priority language will appear.

Audio Soundtrack Language (DVD only)

You can change the audio soundtrack language, selected at the Settings for DVD Operation, to a different language if available. (See page 57.) (This operation works only with discs on which multiple audio soundtrack languages are recorded.)



Press AUDIO in Play mode to display the audio selection on-screen.

- Display disappears after 5 seconds.

Audio attribute 1 type, sampling frequency, bit No. of the disc.



- 1) Press ▲▼ to select desired language.

Number of the audio soundtrack language being played back.

✓ Ready Checklist

- Please read “Basic DVD Operation” on page 20.

[Subtitle language (No.)] [Audio sound track language (No.)]

ENG	English
FRA	French
DEU	German
ITA	Italian
ESP	Spanish
NLD	Dutch
SVE	Swedish
NOR	Norwegian
DAN	Danish
POR	Portuguese
RUS	Russian
JPN	Japanese
CHI	Chinese
KOR	Korean
MAL	Malay
VIE	Vietnamese
THA	Thai
	Other

- Change the No. by pressing ▲▼, and press SET.

[Audio attribute 1 type, sampling frequency, bit No. of the disc (see page 58)]

LPCM	96KHz or 48KHz	16bit 20bit 24bit	Linear PCM disc
Dolby Digital	1ch - 5.1ch		Dolby Digital disc
DTS	1ch - 5.1ch		DTS disc

Notes

- If, after several presses of the button the language does not change, language selection is not offered on the disc.
- When power is turned on again or disc is removed, language reverts to initial setting. If this language is not recorded on the disc, the language recorded will be heard.

*Important: If a remote control button does not work when pressed, press the DVD button on the remote and try the button again.

When  appears on the screen while a button is being operated, it means that the corresponding operation is prohibited by the unit or the disc.

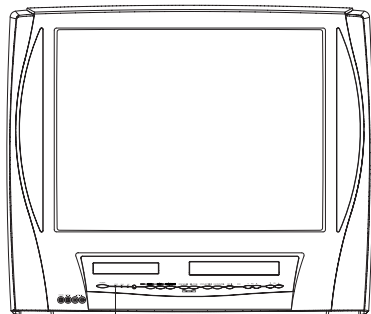

ANGLE Indicator

Notes

- ANGLE Indicator lights up on the unit when a scene recorded at different angles is detected.
- The angle number can be set beforehand so that the angle is switched whenever ANGLE Indicator lights up.

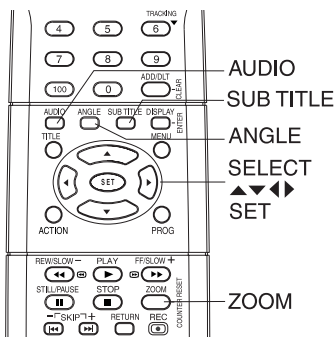

Notes

- Closed captioning will not be displayed while Picture Zoom is used. To see subtitles, set the subtitle feature to ON (see page 48).
- The subtitle cannot be enlarged nor can it's position be changed.
- The picture zoom feature does not work with a Video CD.
- During picture zoom, "ZOOM1" or "ZOOM2" is displayed on-screen.
- Zooming, on some discs, may result in poor picture quality, or not operate.

Multiple Angle Viewing (DVD only)

DVDs may contain scenes shot from multiple camera angles allowing the same scene to be viewed at different angles. You can view these angles, if available, using the ANGLE button.

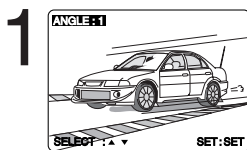

Press ANGLE in Play mode to display the angle selection on-screen.

- Display disappears after 5 seconds.

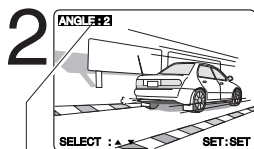

Press ▲▼ to select the desired angle.

Number of angle being played back.

Vocal selection for Karaoke discs (DVD/Video CD)

a Press AUDIO in Play mode to display the audio screen.



- 1) Press ▲▼ (or ◀▶) to select as shown below.
- 2) Press ▶ (or ◀) to set. (DVD only)

- DVD Karaoke (1 vocal) VOCAL ON → VOCAL OFF
- DVD Karaoke (2 vocals) VOCAL V1 + V2 → VOCAL V1 → VOCAL V2 → VOCAL OFF
- Video CD LR → L - R

Picture Zoom (DVD only)

You can enlarge specific portions of a picture and select the zoom ratio using the ZOOM button on the remote during DVD playback.

Set Zoom size.

Press ZOOM repeatedly to change display as follows.

- You can enlarge the center portion of the image to one of 2 magnifications.

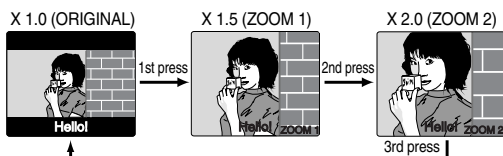

Use the ▲, ▼, ◀ and ▶ buttons to move the position up, down, left and right.

Advanced Operation

Disc Operation (continued)

Title menu (DVD only)

Some DVDs have more than one title, e.g. movies. If the disc offers a title menu, you can select the desired title number. (Operation may vary according to the disc.)



<Example>

Press TITLE* in Play mode to display title screen.

• **Pressing TITLE** again resumes play from the scene when TITLE was first pressed.

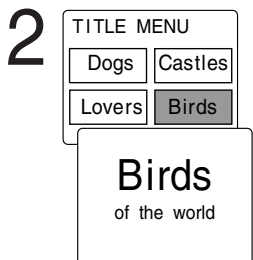

<Example>

1) **Press ▲▼◀▶** or **number Key(s)** to select a title.

2) **Press SET** or **PLAY** to start play.

• Step 2) not necessary when using number key(s).

DVD menu (DVD only)

DVDs may offer a special menu. This menu may include guides to unique contents, audio/subtitle languages, etc. Although contents and operation may vary, the following steps show basic steps for using the menu.

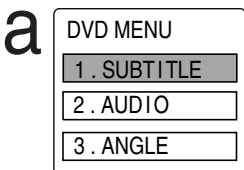

<Example>

Press MENU in Play mode to display DVD menu.

• **Pressing MENU** again resumes play from the scene when MENU was first pressed.

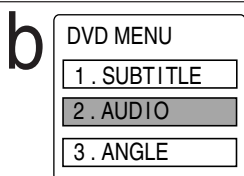

<Example>

1) **Press ▲▼◀▶** or **number key(s)** to select an item.

2) **Press SET** or **PLAY** to access.

• Step 2) not necessary when using number key(s).

Repeat step "b" if more than one menu.

Program Play (Video CD/CD)

You can program specific tracks and order of play.

1 Press ACTION in Stop mode to display MAIN MENU.

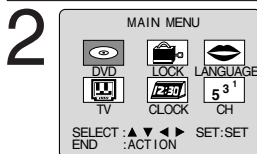

1) **Press ▲▼◀▶** to select "DVD."

2) **Press SET** to display screen.



1) **Press ▲▼** to select "PLAY MODE."

2) **Press SET** to display screen.



1) **Press ▲▼** to select "PROGRAM PLAY."

2) **Press SET** to display screen.

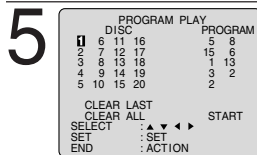

1) **Press ▲▼◀▶** to select a track number. (Track numbers on disc are displayed.)

2) **Press SET** to set.

• Repeat step 5 to select another track.

• The selected track is added on the right side.

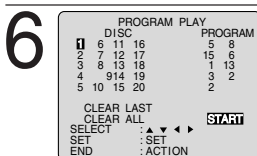

1) **Press ▲▼◀▶** to select "START."

2) **Press SET** to start play of programs in the sequence selected.

• To cancel, **press STOP** during play, then **press CLEAR**.

Notes

- Up to 15 tracks can be programmed.
- "◀" or "▶" (depending on disc) indicates additional PROGRAM PLAY screen. **Press ▲▼◀▶** for next or previous screen.
- **To clear the last program one by one**, **Press ▲▼◀▶** to move to "CLEAR LAST" and **press SET**. (**Pressing CLEAR** also clears last program.)
- **To clear all programs**, **Press ▲▼◀▶** to move to "CLEAR ALL" and **press SET**. (Programs are also cleared when the power is turned off or the disc is removed.)

*Important: If a remote control button does not work when pressed, press the TV_{VCR} , DVD button on the remote and try the button again.

Program Repeat Play (Video CD/CD)

a Do steps 1 through 6 on previous page.

b Press **DISPLAY** to display Disc Information screen.
(Disc Information Screen)

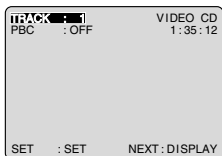

c Press **DISPLAY** again to display Unit Information screen.

d Press **SET** to enter Select mode.
("REPEAT OFF" will flash.)
(Unit Information Screen)



e Press $\blacktriangle\blacktriangledown$ to select "DISC REPEAT."
(Unit Information Screen)



f Press **SET** to set mode.
("DISC REPEAT" stops flashing.)
To cancel, select "REPEAT OFF" in step e, then **press SET**.

Ready Checklist

- Unit is in TV-VCR mode, press TV_{VCR} .
- Video CD or CD is inserted.

Random Play (Video CD/CD)

Tracks are played in a random order.

1 Press **ACTION** in Stop mode to display MAIN MENU.

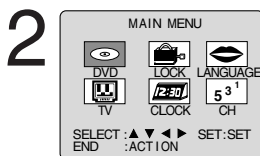

- 1) Press $\blacktriangle\blacktriangledown\blacktriangleleft\blacktriangleright$ to select "DVD."
- 2) Press **SET** to display screen.



- 1) Press $\blacktriangle\blacktriangledown$ to select "PLAY MODE."
- 2) Press **SET** to display screen.

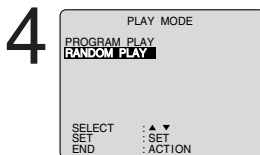

- 1) Press $\blacktriangle\blacktriangledown$ to select "RANDOM PLAY."
- 2) Press **SET** to begin random play.

- To cancel, **press STOP** during play, then **press CLEAR**.

MP3 Playback Operation

***Important:** If a remote control button does not work when pressed, press the DVD button on the remote and try the button again.

MP3 Playback

You can use this unit to play MP3 format audio recorded for personal use with a computer etc. onto a CD-R or CD-RW. Play may not be possible in some cases due to the condition of the recording.

- 1 Press **POWER** on the remote or **DECK**.
- 2 Press **OPEN/CLOSE**, and then place a MP3 disc into the disc tray. Press **OPEN/CLOSE** to close.
- 3 Display **MP3 MENU** and start playing automatically. (The MP3 CD layer is displayed.)

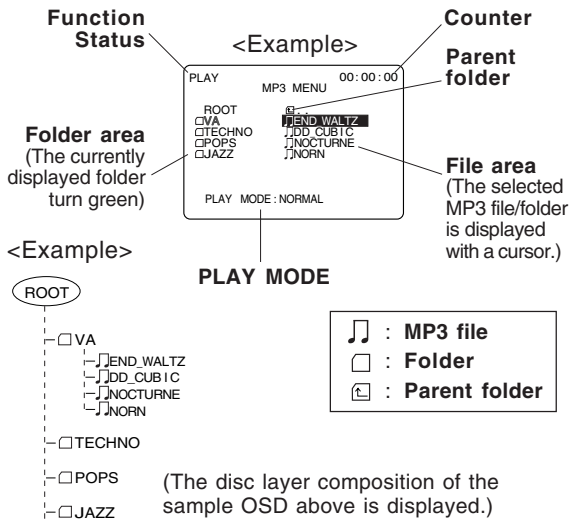

Forward/Reverse Search

Press **FF/SLOW+** or **RR/SLOW-** during play. Press **PLAY** to release.

- Search speed, slow at first, increases with each additional press of the button up to 4 levels.

Forward/Reverse Track Skip

Press **SKIP ►►►** or **◄◄◄ SKIP** during play. Each press skips a track.

- If pressed within first 3 seconds of playback, skips to the previous track. If over 3 seconds, returns to first of that track. (◄◄◄ SKIP only.)
- Only the **SKIP ►►►** or **◄◄◄ SKIP** button can be used for track skip selection during playback. Place unit into Stop mode before performing folder/file selection (see above right.)

- 4 Press **STOP** to stop playing.

- 5 Press **OPEN/CLOSE** to eject the disc. The MP3 MENU is closed automatically.

MP3 playback (During STOP mode)

- 1) Press **▲▼** to select an MP3 file (🎵).
- 2) Press **SET** or **PLAY** to start playback.

Select folder (During STOP mode)

- 1) Press **▲▼** to select a folder (□).
- 2) Press **SET** displays files/folders contained in the folder.

Select parent folder (During STOP mode)

- 1) Press **▲▼** to select a folder (◻).
- 2) Press **SET** changes to the previous layer display.

Note

- Folder area operation cannot be done. Only file area operation is possible.

Select PLAY MODE (During STOP mode)

- 1) Press **◀▶** moves the cursor to PLAY MODE.
- 2) Press **▲▼** to select the desired PLAY MODE (see below).

[PLAY MODE]

NORMAL:

All MP3 files are selected and played back one time only.

SINGLE REPEAT:

The selected MP3 file is played back repeatedly.

FOLDER REPEAT:

The MP3 files contained in the selected folder are played back repeatedly. However, folders below the selected folder are not played back.

DISC REPEAT:

All MP3 files are played back repeatedly.

DVD Operation using On-Screen Displays

When DISPLAY is pressed, On-Screen Displays show disc information (title/chapter/track number, elapsed playing time) and unit information (repeat play, Play mode).



Ready Checklist

- Unit is in DVD mode, press DVD.

1 Press DISPLAY in Play or Stop mode to display "On-Screen Display."

- Each **press** of **DISPLAY** changes the on-screen display as follows. (Please refer to page 54 or 55.)

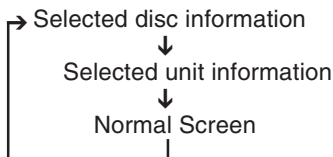

Note

DISPLAY button does not function while DVD TITLE MENU is displayed.

2 1) Press ▲▼ (or ◀▶) to select an item. 2) Press SET to set.

3 1) Press ▲▼ to select the setting. 2) Press SET to set.

<Example of DVD>

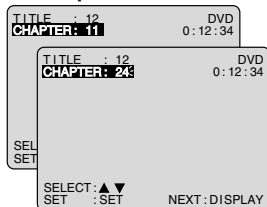

- For some functions the setting will be registered immediately without **pressing SET**.
- When numbers are displayed (e.g. title number), the number keys are also available.

To make corrections,

press ▲▼ and SET repeatedly to move to error, then correct.

- **Pressing ►** is effective for elapsing time instead of the above buttons. **Press ◀** repeatedly to delete the error, then correct.

To return to the normal screen, **press CLEAR or DISPLAY** repeatedly.

Notes

- When **DISPLAY** is pressed during playback of a Video CD with Playback control, the **number keys** are not available on the displayed screen. In this case, **press DISPLAY** again to remove the displayed screen.
- When  appears on the screen while a button is being operated, it means that the corresponding operation is prohibited by the unit or the disc.

<Example of Video CD>

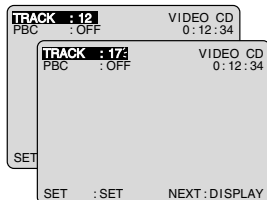

DVD Operation using On-Screen Displays (continued)

Detailed Descriptions of Each On-Screen Display

Disc information screen (for DVD)

1. TITLE No.

- Change the No. by pressing **▲▼*** or the **number keys**, and press **SET**.

2. Chapter No.

- Change the No. by pressing **▲▼** or the **number keys**, and press **SET**.

3. Disc currently being played

4. Elapsed playing time

The screen may be changed by selecting the elapsed time.

- Change the elapsed time by pressing **number keys**, and press **SET**.

(e.g.) 01 : 23 : 45 0 → 1 → 2 → 3 → 4 → 5

- This function does not work with some discs.

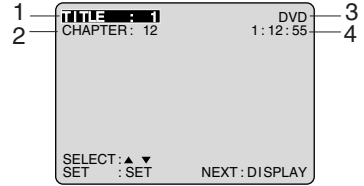

Disc information screen (for Video CD/ CD)

A. Track No.

- Change the No. by pressing **▲▼** or the **number keys**, and press **SET**.

B. Playback control ON/OFF

[Video CD with playback control only]

ON	Video CD menu play is displayed.
OFF	Video CD menu play is cleared.

C. Disc currently being played

Video CD	CD
----------	----

D. Elapsed playing time

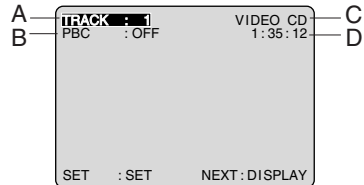

Notes

- Track No. and elapsed playing time are not displayed during play started from menu of Video CDs with playback control.
- When  appears on the screen while a button is being operated, it means that the corresponding operation is prohibited by the unit or the disc.

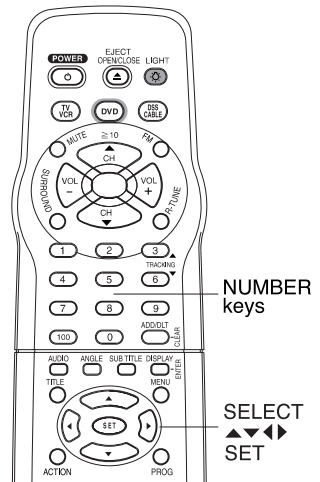

*Important: If a remote control button does not work when pressed, press the DVD button on the remote and try the button again.

Detailed Descriptions of Each On-Screen Display

Unit information screen

- Change the desired mode during play by pressing ▲▼, and press SET.

a. Repeat Play

DVD	CHAPTER REPEAT	TITLE REPEAT	REPEAT OFF
Video CD/CD	TRACK REPEAT	DISC REPEAT	REPEAT OFF

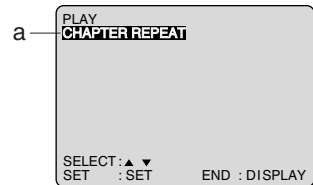

b. Play mode [Video CD/ CD only] (See page 53 or 54.)

PROGRAM PLAY	program play
RANDOM PLAY	random play
-	normal play



Advanced Operation

For your reference

- CHAPTER/TITLE REPEAT PLAY (DVD)

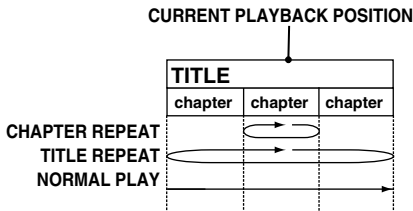

- TRACK/DISC REPEAT PLAY (Video CD/CD)

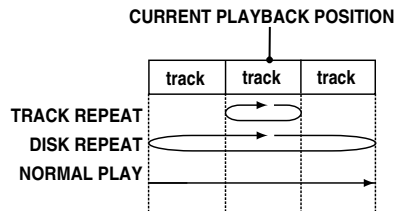

Note

- For repeat play in VCR mode, see page 36.

DVD Lock Feature

*Important: If a remote control button does not work when pressed, press the  DVD button on the remote and try the button again.

You can prevent playback of DVDs in a specific rating level which may be unsuitable for children.

- Some DVDs are encoded with a rating level. If the disc rating is higher (stricter) than the one you preset, playback will be prohibited.

Caution

Discs not encoded with rating level will play even if the jacket states it is for mature audiences. For these discs, the DVD Lock Ratings will not work.

DVD Lock Ratings (DVD only)

Perform DVD Lock setting in TV mode.
Enter your secret code to display LOCK menu.
(Do "Secret Code" steps on page 40.)

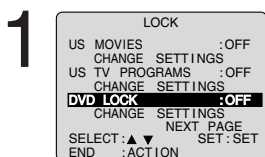

- 1) Press **▲▼*** to select "DVD LOCK."
- 2) Press **SET** to set "ON" or "OFF."

- "ON" → DVD Lock is activated.
- "OFF" → DVD Lock is deactivated.

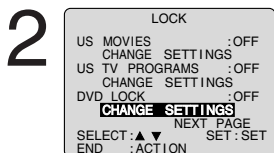

- 1) Press **▲▼** to select "CHANGE SETTINGS."
- 2) Press **SET** to display screen.

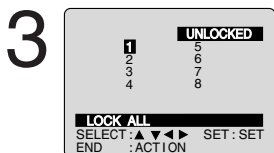

- 1) Press **▲▼◀▶** to select rating level.
- 2) Press **SET** to select "LOCKED" or "UNLOCKED."

LEVEL 1 : LOCK ALL:

Playback of all DVDs, CDs and Video CDs is prohibited. (Use to prohibit play of mature theme DVDs not encoded with rating level.)

LEVEL 2 : DVDs expressly for children can be played back.

DVDs for general audiences/children can be played back. (DVDs with mature content are prohibited.)

LEVEL 8 : NO LIMIT: (Factory preset)

All DVDs can be played back.

- Ratings which are highlighted in Green will be blocked; those not highlighted (white letters) will not be blocked.

4 Press **ACTION** three times to end setup.

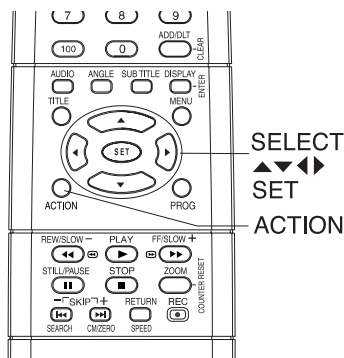

<When DVD Lock is activated>

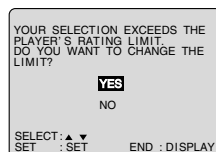

After DVD Lock is set and a blocked DVD is played, this message will appear. The message may differ depending on the disc.

To continue viewing a blocked program for now,

Press **▲▼** to select "YES" and **SET**. Then, enter your 4-digit secret code. When "NO" is selected, blocked programs cannot be viewed.

To change DVD LOCK settings

After entering your secret code in step 3 on page 40, select "OFF" to deactivate DVD Lock or change the rating level.

Settings for DVD Operation

- 1 Press **ACTION** in Stop mode to display MAIN MENU.

2

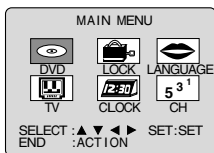

- 1) Press **▲▼◀▶** to select "DVD."
- 2) Press **SET** to display screen.

3



- 1) Press **▲▼** to select an item.
- 2) Press **SET** to set.

DISC LANGUAGES (See below.)

Any languages offered on the disc can be set. If a language not offered is set, the original disc language will be selected.

AUDIO OUTPUT (See page 58.)

You can set the audio output that comes from the digital audio output terminal.

STILL MODE (See page 59.)

To select "FIELD" or "FRAME" to prevent jitter or to make small text or fine patterns clearly visible in a still picture. When "AUTO" is set "FIELD" or "FRAME" is selected automatically.

TV MODE (See page 59.)

To select whether the video material for a wide-screen will be played back in Pan & Scan style or in Letterbox style.

DISC LANGUAGES (DVD only)

To select and set the language of the audio soundtrack, subtitles, or title/DVD menus for all discs to be played.

4



- 1) Press **▲▼** to select "DISC LANGUAGES."
- 2) Press **SET** to display screen.

5



- 1) Press **▲▼** to select an item.
- 2) Press **SET** repeatedly for desired language. (Please refer right.)

6

Press **ACTION** to redisplay DVD menu and go to step 3 to setup another item. Or, press **ACTION** three times to exit.

Once initial settings are done, they remain in memory (even after power off) until changed. This means the unit will always operate under the same conditions (especially DVDs) each time.



Ready Checklist

- Unit is in TV-VCR mode, press **TV** **VCR**.

"AUDIO" selections

To select the audio soundtrack language. (factory preset: English)

English/Spanish/French

Original: Original disc language

OTHER **:** Other language selection*1

"SUBTITLE" selections

To select the subtitle language.

(Factory preset: AUTO)

AUTO: Same language selected for "AUDIO"

- If language set for "AUDIO" is used in playback, subtitles will not appear.
- If another language is used during playback, the subtitles will appear in the language selected at "AUDIO" setup.

English/Spanish/French

OTHER **:** Other language selection*1

"MENUS" selections

(factory preset: English)

To select the language used in title menus or DVD menus.

English/Spanish/French

OTHER **:** Other language selection*1

To enter **OTHER **** code number**, Press **number keys** (Please refer to language codes on page 63).

To make corrections, press **◀** repeatedly to delete language code number, and correct.

*1 If the selected language is not offered, the original disc language is selected.

Settings for DVD Operation (continued)

AUDIO OUTPUT

Select the digital output to be output from the optical digital audio output connector of the unit.

1 Do steps 1 and 2 on page 57.



- 1) Press **▲▼*** to select "AUDIO OUTPUT."
- 2) Press **SET** to display screen.

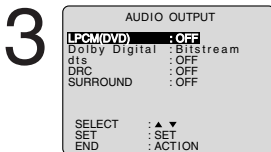

- 1) Press **▲▼** to select an item.
- 2) Press **SET** repeatedly for output. (See below.)

"LPCM (DVD)" selections

OFF: Linear PCM of less than 48 kHz/16 bit is output. When playing DVDs recorded in linear PCM of over 48 kHz/20 bit or 96 kHz, no digital audio is output. (Factory preset)

PCM: When playing DVDs recorded in linear PCM of 48 kHz/20 bit/24 bit or 96 kHz, digital audio converted to 48 kHz/16 bit is output. (Digital output of PCM audio is restricted to 48 kHz/16 bit or below for copyright protection.)

"Dolby Digital" selections

Bitstream: Dolby Digital bitstream (1ch-5.1ch) is output. (Factory preset)

OFF: No output.

"dts" selections

Bitstream: dts bitstream is output. (Factory preset)

OFF: No output.

"DRC (Dynamic Range Compression)" selections

OFF: Normal audio range is selected. (Factory preset)

ON: For dynamic sound even at low volume, this is useful for late-night listening. [Dolby Digital DVDs only].

"SURROUND" selections

Surround Sound creates the effect of sound coming from non-existent rear speakers even when only connected to a 2-channel stereo system.

OFF: No Surround Sound effect. (Factory preset)

ON: Surround Sound effect.

4 Press **ACTION** to redisplay DVD menu and go to step 2 to setup another item. Or, press **ACTION** three times to exit.

Type of amplifier to be connected	Recommended setting		
	LPCM (DVD)	Dolby Digital	dts
No amplifier is connected	OFF	OFF	OFF
AV amplifier (with digital audio input connector) without Dolby Digital/dts decoder	PCM*1	OFF*2	OFF*2
AV amplifier including Dolby Digital decoder	PCM*1	Bitstream	OFF
AV amplifier including Dolby Digital/dts decoder	PCM*1	Bitstream	Bitstream*3

- Make settings according to amplifier connected to optical audio output as shown in above table.
- When a dts decoder is not connected, to enjoy dts DVD, please select audio output other than dts at the dts DVD menu screen. Otherwise, there will be no sound from the unit speakers.

- *1 Audio output from unit is converted to 48 kHz/16 bit in addition to audio from digital audio output.
To enjoy high quality sound at 48 kHz/20 bit / 24 bit or 96 kHz, connect the amplifier or decoder directly to the audio output connectors, not to the digital audio output connector. [Select "OFF" at the "LPCM (DVD)"].
- *2 When connecting an amplifier (with an optical digital input connector) which does not contain the Dolby Digital or dts decoder, be sure to select "OFF".
If "Bitstream" is selected, starting DVD play may cause such a high level of noise as to be harmful to your ears and damage the speakers.
- *3 When a dts decoder is connected, please select "Bitstream" in "dts". If "OFF" is selected, there will be no sound.

Notes

- Turn off other surround effects when using this surround effect.
- For optimum effect, the distance between the unit and the listener should be about 3 or 4 times the distance between the right and left front speakers.

*Important: If a remote control button does not work when pressed, press the DVD button on the remote and try the button again.

STILL MODE

Set to reduce jitter in a displayed still picture or a motion picture.

1 Do steps 1 and 2 on page 57.



- 1) Press ▲▼ to select "STILL MODE."
- 2) Press SET repeatedly for mode. (See below)

- AUTO:** "FIELD" (Field still) or "FRAME" (Frame still) is automatically selected during the still mode. (Factory preset)
- FIELD:** "FIELD" (Field still) is always selected. This setting will reduce jitter when compared with "AUTO" on some discs.
- FRAME:** "FRAME" (Frame still) is always selected. Some texts and fine patterns will be seen clearly when compared with "AUTO" on some discs.

3 Press ACTION twice to exit this mode.

Selecting TV MODE

Set the screen display style for wide-screen video material playback.

a Do steps 1 and 2 on page 57.

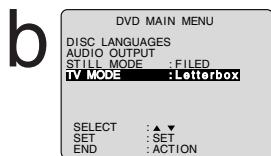

- 1) Press ▲▼ to select "TV MODE."
- 2) Press SET repeatedly for mode. (See below.)

- Pan & Scan :** Wide screen video data is played in Pan & Scan style (left and right of screen is trimmed.)
- Video data not formatted in Pan & Scan will play in letterbox style.
- Letterbox :** Wide screen video data is played in Letterbox style (top and bottom of screen has black margin).

C Press ACTION twice to exit this mode.

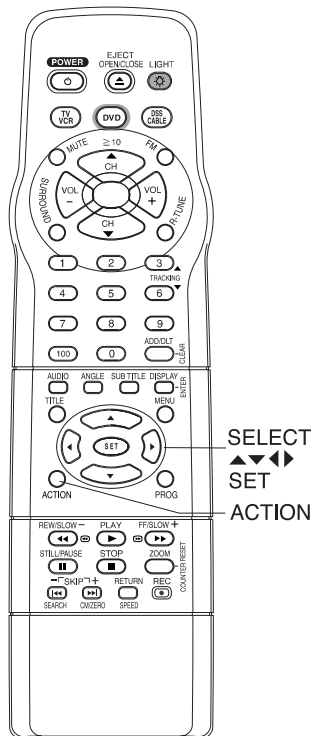

Example

- Pan & Scan (Factory preset)

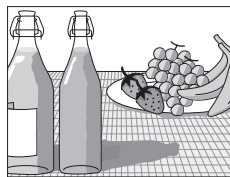

- Letterbox



For Your Information

Before Requesting Service

Check the following points once again if you are having trouble with your unit.

Power	Correction
No power...	<ul style="list-style-type: none"> • Completely insert Power Plug into an AC outlet. • Set POWER button to ON.
Power turns itself off...	<ul style="list-style-type: none"> • Auto power-off (shutoff) occurs after about 5 min. in DVD mode with no operation, or if there is no broadcast signal in TV or Playback mode. Turn the power back on. (P. 21, 37)
Monitor	Correction
No picture or sound...	<ul style="list-style-type: none"> • Make sure your antenna system (TV or CABLE), is correctly set. (P. 11) • Completely insert Power Plug into an AC outlet. • Set POWER button to ON.
Poor picture with normal sound...	<ul style="list-style-type: none"> • Adjust BRIGHTNESS, SHARPNESS, and PICTURE controls in the SET UP Video Adjustment. (P. 47)
Poor sound with normal picture...	<ul style="list-style-type: none"> • Adjust VOLUME control. (P. 22)
Poor TV reception...	<ul style="list-style-type: none"> • Adjust SHARPNESS and PICTURE controls in the SET UP Video Adjustment. (P. 47)
No color or poor color...	<ul style="list-style-type: none"> • Adjust TINT and COLOR controls in the SET UP Video Adjustment. (P. 47)
Ghost (multiple) images...	<ul style="list-style-type: none"> • Install a directional antenna.
TV programs cannot be watched...	<ul style="list-style-type: none"> • Make sure the selected channel is in unit's memory. (P. 16)
Channel cannot be selected...	<ul style="list-style-type: none"> • Only the channel begin recorded can be viewed on this unit.
VCR	Correction
TV program cannot be recorded...	<ul style="list-style-type: none"> • Make sure your antenna system (TV or CABLE), is correctly set. (P. 11) • Make sure cassette record tab is intact. (P. 4)
Timer recording cannot be performed...	<ul style="list-style-type: none"> • Check that clock is set to current time and date. • Make sure DSS/CABLE box (if used) is left on and tuned to channel to be recorded. • Set recording Start/Stop times correctly. (P. 30, 31) • Timer recording may not be performed or continued if a power interruption of more than 1 minute occurs before or during a Timer Recording, even after power is restored.
No playback picture, or the playback picture is noisy or contains streaks...	<ul style="list-style-type: none"> • Adjust TRACKING control in either direction. (P. 6) • Try Head Cleaning. (P. 6)
VCR cannot be controlled...	<ul style="list-style-type: none"> • Make sure VCR LOCK is set to off. (P. 39)
Remote Control	Correction
Unit cannot be controlled...	<ul style="list-style-type: none"> • Aim Remote directly at the remote sensor on the unit. (P. 10) • Avoid any object blocking signal path. • Inspect the remote batteries. (P. 4) • Make sure VCR LOCK is set to off. (P. 39) • Exposing unit remote sensor to direct fluorescent or outdoor light may cause signal interference.
ACTION, PLAY, SELECT, SET POWER, etc. buttons cannot be selected...	<ul style="list-style-type: none"> • Press TV/VCR for TV-VCR mode. (P. 32) • Press DVD for DVD mode. (P. 32) • Press FM for FM mode. (P. 32) • Check remote batteries.

DVD/Video CD/CD	Correction
Play fails to start even when PLAY is pressed...	<ul style="list-style-type: none"> • This unit cannot play discs other than DVDs, Video CDs and CDs. • The disc may be dirty and require cleaning.
Play starts but then stops immediately...	<ul style="list-style-type: none"> • Be sure disc is installed with label side up.
Picture is distorted during rapid advance or rapid reverse...	<ul style="list-style-type: none"> • The picture will be somewhat distorted at times: this is normal.
No Forward/Reverse search play...	<ul style="list-style-type: none"> • Some discs may have sections which prohibit Forward/Reverse search. (P. 21)
Play does not start even when title is selected...	<ul style="list-style-type: none"> • Confirm the "DVD LOCK" setting. (P. 56)
Audio soundtrack and/or subtitle language is not the one selected at the initial settings...	<ul style="list-style-type: none"> • If the audio soundtrack and/or subtitle language selected at DVD initial settings does not exist on the disc, it will not be accessible.
No subtitles...	<ul style="list-style-type: none"> • Subtitles appear only when available on disc. • Select "ON" at the "Subtitle Language" section (P. 48) to display subtitles.
Alternative audio soundtrack (or subtitle) language cannot be selected...	<ul style="list-style-type: none"> • Alternative language cannot be selected with discs which do not contain more than one language. • For some discs, alternative language cannot be selected with the AUDIO or SUB TITLE button. Try selecting it from the DVD menu if available.
Angle cannot be changed...	<ul style="list-style-type: none"> • This function is dependent on software availability. Even if disc has multiple angles, they may be recorded for specific scenes only (ANGLE Indicator on unit lights up). (P. 49)
Miscellaneous	Correction
Video cassette cannot be inserted...	<ul style="list-style-type: none"> • Insert the cassette window side up; record tab facing you.
Video cassette cannot be removed...	<ul style="list-style-type: none"> • Completely insert Power Plug into an AC outlet.
Eject does not function or insertion cannot be done...	<ul style="list-style-type: none"> • Turn the POWER off and then on, and try ejecting or inserting the tape again.
Video cassette ejects when a recording is started, or the power is turned off for timer recording...	<ul style="list-style-type: none"> • Make sure cassette record tab is intact. (P. 4)
The disc cannot be removed...	<ul style="list-style-type: none"> • First, unplug unit. Then, prepare a rigid wire (e.g. an extended paper clip, etc.) and, applying moderate force, insert it straight into the hole at the base of the tray. The tray will eject a little. Now, pull the tray all the way out and remove the disc. (P. 9)
In Stop mode, the VCR motor (CYLINDER) continues to rotate...	<ul style="list-style-type: none"> • To enable Quick Play mechanism, the VCR cylinder will rotate for about 3 minutes. This reduces response time from Stop to Play mode and from Play to Rewind Search mode.

If you cannot resolve the problem, please call the Customer Call Center for product assistance at 1-800-211-PANA (7262.)

To locate an authorized servicenter, please call toll free 1-800-211-PANA (7262.) or send e-mail to : consumerproducts@panasonic.com

Warning and Instruction Displays

These displays will alert you of a missed operation or provide further instructions.

OSD	Caution	Page
PLEASE SET CLOCK BEFORE PROGRAMMING	<ul style="list-style-type: none"> If you attempt to set or review a Timer Recording or set the On-Timer and the Clock is not set... 	16, 17
CHECK CASSETTE RECORD TAB	<ul style="list-style-type: none"> If you press REC, and a cassette is inserted with no record tab... 	4, 18
TO CANCEL TIMER REC HOLD DOWN STOP KEY FOR APPROX 3 SEC	<ul style="list-style-type: none"> If you press STOP during a Timer Recording... 	31
NO CASSETTE PLEASE INSERT A CASSETTE	<ul style="list-style-type: none"> If you press PLAY, FF, REW, or REC without a cassette inserted... 	18
PLEASE PREPARE FOR TIMER REC	<ul style="list-style-type: none"> If the unit is not in Stop mode or a cassette with record tab is not inserted two minutes before a Timer Recording is about to begin... 	30, 31
VIDEO HEADS MAY NEED CLEANING PLEASE INSERT HEAD CLEANING CASSETTE OR REFER TO MANUAL END: PLAY	<ul style="list-style-type: none"> If head cleaning becomes necessary while playing back a tape... 	6
VCR LOCK ACTIVATED	<ul style="list-style-type: none"> If you press a function button other than STOP/EJECT or POWER while the unit is in VCR Lock mode... 	39
PLEASE CHECK THE DISC, AND FOR STAINS OR SCRATCHES ON DISC	<ul style="list-style-type: none"> If you press PLAY, or the unit reads data from a stained or scratched disc in DVD mode. Also, if the type of disc is other than DVD, Video CD or CD... 	7
IT IS PROHIBITED TO COPY DVD/ VIDEO CD/CD TO VHS	<ul style="list-style-type: none"> If you press REC in DVD mode... 	18, 19

Language Code List

Enter the appropriate code number for the initial settings “AUDIO”, “SUBTITLE” and/or “MENUS” (see page 57).

Code	Language	Code	Language	Code	Language	Code	Language
6565	Afar	7079	Faroese	7678	Lingala	8375	Slovak
6566	Abkhazian	7082	French	7679	Laothian	8376	Slovenian
6570	Afrikaans	7089	Frisian	7684	Lithuanian	8377	Samoan
6577	Ameharic	7165	Irish	7686	Latvian, Lattish	8378	Shona
6582	Arabic	7168	Scots Gaelic	7771	Malagasy	8379	Somali
6583	Assamese	7176	Galician	7773	Maori	8381	Albanian
6588	Aymara	7178	Guarani	7775	Macedonian	8382	Serbian
6590	Azerbaijani	7185	Gujarati	7776	Malayalam	8385	Sundanese
6665	Bashkir	7265	Hausa	7778	Mongolian	8386	Swedish
6669	Byelorussian	7273	Hindi	7779	Moldavian	8387	Swahili
6671	Bulgarian	7282	Croatian	7782	Marathi	8465	Tamil
6672	Bihari	7285	Hungarian	7783	Malay	8469	Telugu
6678	Bengali; Bangla	7289	Armenian	7784	Maltese	8471	Tajik
6679	Tibetan	7365	Interlingua	7789	Burmese	8472	Thai
6682	Breton	7378	Indonesian	7865	Nauru	8473	Tigrinya
6765	Catalan	7383	Icelandic	7869	Nepali	8475	Turkmen
6779	Corsican	7384	Italian	7876	Dutch	8476	Tagalog
6783	Czech	7387	Hebrew	7879	Norwegian	8479	Tonga
6789	Welsh	7465	Japanese	7982	Oriya	8482	Turkish
6865	Danish	7473	Yiddish	8065	Panjabi	8484	Tatar
6869	German	7487	Javanese	8076	Polish	8487	Twi
6890	Bhutani	7565	Georgian	8083	Pashto, Pushto	8575	Ukrainian
6976	Greek	7575	Kazakh	8084	Portuguese	8582	Urdu
6978	English	7576	Greenlandic	8185	Quechua	8590	Uzbek
6979	Esperanto	7577	Cambodian	8277	Rhaeto-Romance	8673	Vietnamese
6983	Spanish	7578	Kannada	8279	Romanian	8679	Volapük
6984	Estonian	7579	Korean	8285	Russian	8779	Wolof
6985	Basque	7583	Kashmiri	8365	Sanskrit	8872	Xhosa
7065	Persian	7585	Kurdish	8368	Sindhi	8979	Yoruba
7073	Finnish	7589	Kirghiz	8372	Serbo-Croatian	9072	Chinese
7074	Fiji	7665	Latin	8373	Singhalese	9085	Zulu

Conexión de la antena externa

Desenganche la antena del televisor o de la videograbadora que tuviera anteriormente y conéctela a la parte trasera del registrador Combinación de TV/DVD/VDR, como se muestra en el diagrama. Si el sistema de su antena tiene conductores UHF y VHF separados, usted necesita un mezclador de banda UHF/VHF (no viene con el equipo.)

ADVERTENCIA:

Al utilizar cables coaxiales RF del "Tipo tuerca", solo debe apretarse con los dedos. Si se aprieta demasiado los cables pueden resultar dañados.

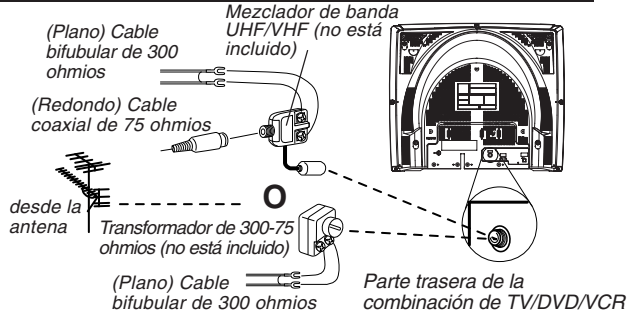

Conexiones de TV cable

■ Sin un decodificador de TV cable

Podrá;

- grabar o ver canales sin codificar.

No Podrá;

- grabar o ver canales codificados.
- ver otro canal que no sea el seleccionado para cualquier tipo de grabación.

Parte trasera de la combinación de TV/DVD/VCR

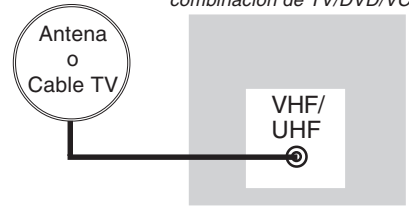

■ Con un decodificador de TV cable

Podrá;

- grabar o ver cualquier canal incluso los canales codificados.

NOTA : El canal deberá ser seleccionado en el decodificador de TV cable.

No Podrá;

- ver otro canal que no sea el seleccionado para cualquier tipo de grabación.
- hacer una grabación con temporizador de un canal a menos que lo seleccione en el decodificador de TV cable.

Parte trasera de la combinación de TV/DVD/VCR

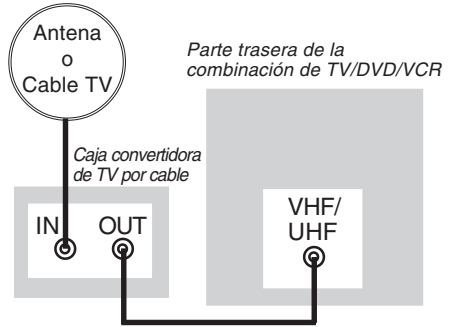

Para ver y grabar un canal codificado/ no codificado

Sintonice el canal del Registrador de la combinación de VCR/TV en el canal de salida de la caja convertidora de televisión por cable (por ejemplo el canal 3.) Después, seleccione en el decodificador de TV cable el canal que se quiera ver o grabar.

■ Con un receptor DSS

Podrá;

- grabar o ver cualquier canal incluso los canales codificados.

NOTA : El canal deberá ser seleccionado en el receptor DSS.

No Podrá;

- ver otro canal que no sea el seleccionado para cualquier tipo de grabación.
- hacer una grabación con temporizador de un canal a menos que lo seleccione en el receptor DSS.

NOTA : El receptor DSS debe estar apagado para ver programas desde un decodificador de TV cable o desde la antena. Consulte el manual del receptor DSS para más detalles.

Parte trasera de la combinación de TV/DVD/VCR

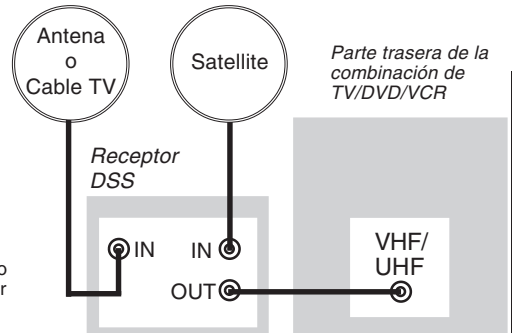

Spanish Quick Use Guide/Gú a para á pida consulta

Realizando Configuración Inicial

Presione **TV/VCR** para modo del TV-VCR

- 1** Tape el cable eléctrico de la unidad en el enchufe de pared de la CA.
- 2** **POWER** de la prensa en el telecontrol o la unidad. La unidad se adelanta y comienzo auto del canal y del reloj.

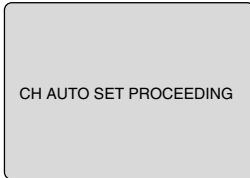

- Si usa convertidor de cable, enciéndala y seleccione el Servicio Público de Canales de Televisión (PBS) en su horario de uso o tiempo de su zona. Si utiliza receptor DSS este debe de estar apagado.

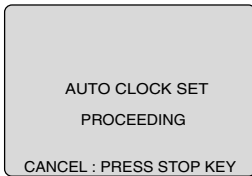

- 3** Selecciones se realizarán automáticamente cuando la configuración termine, la pantalla siguiente aparecerá.

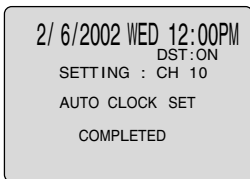

Si "AUTO CLOCK SET IS INCOMPLETE" aparece en pantalla, coloque el tiempo usando el procedimiento manual (MANUAL CLOCK SET), vealo enseguida.

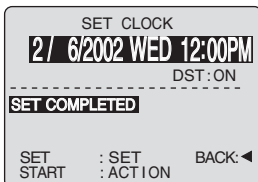

Ajuste Manual del Reloj

Si el ajuste automático del reloj no se ha completado, ajuste el reloj manualmente de la siguiente manera:

- 1) Presione la tecla **ACTION** en el control remoto para visualizar la pantalla del menú **RELOJ**.
- 2) Presione **▲▼** para seleccionar el mes y **SET** para ajustar. De la misma forma, seleccione y ajuste la fecha, año, hora y DST (Hora de Verano).
- 3) Presione dos veces la tecla **ACTION** para poner el **RELOJ** en marcha y salir.

Ajustar de nuevo el reloj

- 1** Presione **ACTION** para exhiba el menú.

2

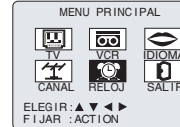

Presione **▲▼◀▶** para seleccionar "RELOJ". Presione **SET**.

3

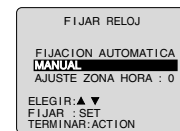

Presione **▲▼** para seleccionar "MANUAL" y luego presione **SET**.

4

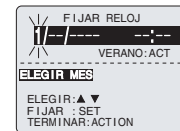

Presione **▲▼** y **SET** para seleccionar y ajustar la hora y la fecha.

5

Presione **ACTION** dos veces para que el reloj comience a funcionar y salir desde este modo.

Operaciones básicas para la reproducción

- 1 Inserte un cassette.**
 - El videograbador combinado se enciende automáticamente.
- 2 Presione PLAY.**
 - La reproducción comienza automáticamente si el cassette no tiene la lengüeta para prevención de grabación.
 - Para encontrar una escena en particular
 - Búsqueda hacia adelante → Presione FF/SLOW+
 - Búsqueda hacia atrás → Presione REW/SLOW-
 - Para ver una imagen fija (congelada) → Presione STILL/PAUSE
 - Para ver en cámara lenta → Presione FF/SLOW+ o REW/SLOW- en el modo de imagen fija
 - Para ver imágenes cuadro a cuadro → Presione STILL/PAUSE en el modo de imagen fija
 - Para parar → Presione STOP
 - Para rebobinar la cinta → Presione REW/SLOW-
 - Para hacer avanzar la cinta rápidamente → Presione FF/SLOW+
 - Para expulsar el cassette → Presione EJECT en el control remoto o STOP/EJECT en el videograbador combinado

Operaciones básicas para la grabación

- 1 Inserte un el cassette con la lengüeta para prevención de grabado.**
 - El videograbador combinado se enciende automáticamente.
- 2 Seleccione el canal.**

Presione CH ▲▼ o las teclas numéricas correspondiente.
- 3 Seleccione la velocidad de grabación.**

Presione SPEED.

SP = reproducción normal
 LP = reproducción larga
 SLP = reproducción super larga

 - La velocidad seleccionada debe aparecer en la pantalla.
- 4 Comience la grabación.**

Presione REC.

 - Para editar partes no deseadas de una grabación, presione STILL/PAUSE para hacer una pausa durante la grabación.
 - No podrá ver otro canal durante la grabación.
 - Para parar → Presione STOP.
 - **El videograbador combinado deja de grabar a una hora prefijada.** (Grabación de un toque)
 Presione REC repetidamente para ajustar la hora de grabación (30 min - 4 horas.)

Grabación con temporizador

- 1 Exhiba FIJAR PROGRAMACION.**

Presione PROG.
- 2 Exhiba TEMPORIZADOR.**

1) Presione ▲▼ para seleccionar.
 2) Presione SET para exhibir.

 - Si ya existe un programa en la memoria, presione ▲▼ y SET para seleccionar un número de programa sin usar.
- 3 Ajuste la fecha de grabación.**

1) Presione ▲▼ para seleccionar.
 2) Presione SET o ◀ ▶ para ajustar.

 - 1 - 31 = Grabación única
 - DIARIO = a la misma hora de lunes a viernes
 - SEMANAL = a la misma hora una vez a la semana

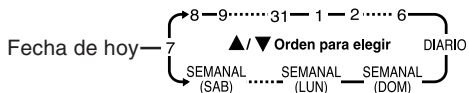

Repita el paso 3 para ajustar: hora de comienzo, hora de parada, canal (o LINEA para una fuente exterior), velocidad (SP, LP, SLP).

- 4 Termine el programa.**

Presione PROG

Para introducir más programas. presione ▲▼ y SET para seleccionar y ajustar el número de programa en blanco, y luego repita los pasos 3.

- 5 Salga de este modo.**

Presione PROG dos veces

 - Si está usando un decodificador de TV cable, asegúrese que se encuentra en el canal deseado y que la alimentación queda conectada para grabar con temporizador.
 - El indicador PROG TIMER se enciende en el videograbador combinado.

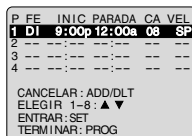
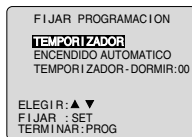

Spanish Quick Use Guide/Guía para rápida consulta

Operaciones básicas del DVD

1 Presione **POWER** en el control remoto o el aparato.

2 Elija el modo **DVD**
Presione **DVD**.

3 Introducir un disco.

1) Presione **OPEN/CLOSE**.

2) Ponga un disco en la bandeja de disco.

- Sujete el disco sin tocar ninguna de sus superficies, póngalo con el lado donde esté impreso el título hacia arriba, alinéelo con las guías y póngalo en su posición apropiada. Disco de 3" (8 cm) Disco de 5" (12 cm)

4 Iniciar la reproducción

Presione **PLAY**.

La bandeja del disco se cierra automáticamente.

- Si está usando un DVD interactivo (Interactive DVD) o un Video CD con control de reproducción (playback control) y aparece un menú de títulos (**TITLE MENU**) en la pantalla, siga al paso 5.

5 Elija el artículo deseado.

1) Presione **▲▼◀▶** o las teclas numéricas.

2) Presione **SET** para la reproducción.

Si usa las teclas numéricas, la reproducción comienza automáticamente.

6 Parar la reproducción.

Presione **STOP**.

7 Expulsar el disco.

Presione **OPEN/CLOSE**.

■ **Para buscar una escena particular**

Búsqueda hacia adelante

Presione **FF/SLOW+** en el modo de reproducción.

Búsqueda hacia atrás

Presione **REW/SLOW-** en el modo de reproducción.

(Para liberar, presione **PLAY**)

■ **Para saltar un capítulo o una pista**

Salto hacia adelante

Presione **SKIP ▶▶I** en el modo de reproducción.

Un capítulo (DVD) o una pista (Video CD/CD) se salta cada vez que se oprime la tecla.

Salto hacia atrás

Presione **I◀◀ SKIP** en el modo de reproducción.

■ **Para ver una imagen fija**

Presione **STILL/PAUSE** durante la reproducción.

(Para liberar, presione **PLAY**)

■ **Para ver imágenes cuadro a cuadro (DVD/Video CD)**

Presione **STILL/PAUSE** en el modo de imagen fija.

La imagen avanza un cuadro cada vez que presiona la tecla.

(Para volver a la reproducción normal, presione **PLAY**.)

■ **Para ver en cámara lenta (DVD/Video CD)**

Presione **FF/SLOW+** o **REW/SLOW-** en el modo de imagen fija.

(Para liberar, presione **PLAY**)

Funcionamiento del DVD utilizando visualizaciones en pantalla

Cuando se presiona **DISPLAY**, la visualización en pantalla muestra la información del disco (título / capítulo / número de lista, tiempo transcurrido de reproducción, audio / idioma del subtítulo, y ángulo) e información (repetir la reproducción, modo reproducción, Karaoke vocal encendido / apagado, etc.).

1 Visualizar Visualizaciones en pantalla.

Presione **DISPLAY** en el modo reproducción o parada.

- Cada vez que se presione **DISPLAY**, la visualización en pantalla cambia como se muestra a continuación.

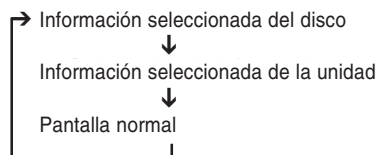

2 Selección del ítem deseado

1) Presione **▲▼** (o **◀▶**) para seleccionar.

2) Presione **SET** para ajustar

3 <Ejemplo de DVD>

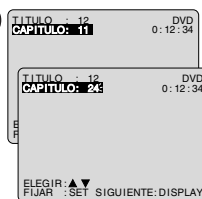

Selección del ajuste deseado

1) Presione **▲▼** para seleccionar.

2) Presione **SET** para ajustar.

<Ejemplo de Video CD>



Para volver a la pantalla normal, Presione repetidamente CLEAR o DISPLAY.

Cambio del idioma de subtítulos [DVD solamente]

El idioma de los subtítulos seleccionado al hacer las fijaciones iniciales se puede cambiar por otro idioma diferente, si éste se encuentra disponible.



1 Presione SUBTITLE durante la reproducción.

Cuando no haya subtítulos grabados, “.” se visualizará en lugar del número de idioma.



2 Seleccionar el idioma deseado.

- 1) Presione $\blacktriangle \blacktriangledown$ para seleccionar idioma.
- 2) Presione $\blacktriangleleft \blacktriangleright$ para ajustar.
- 3) Presione \blacktriangle (o \blacktriangledown) para seleccionar “ACTIVO” o “INACTIVO.”

Cambio del idioma de la pista de sonido [DVD solamente]

El idioma de la pista de sonido seleccionado al hacer las fijaciones iniciales se puede cambiar por otro idioma diferente, si éste se encuentra disponible.

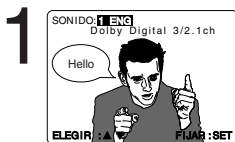

1 Visualizar la pantalla AUDIO.

Presione AUDIO durante la reproducción.



2 Seleccionar el idioma deseado.

Presione $\blacktriangle \blacktriangledown$ para seleccionar idioma.

Visión desde otro ángulo [DVD solamente]

Algunos discos DVD tienen escenas que han sido filmadas simultáneamente desde un número de ángulos diferentes. Con estos discos, la misma escena podrá verse desde cada uno de estos ángulos diferentes utilizando el botón ANGLE.

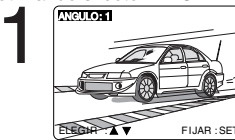

1 Visualizar la pantalla de ángulo.

Presione ANGLE durante la reproducción.

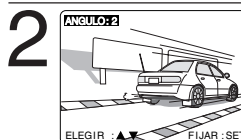

2 Seleccionar el ángulo deseado.

Presione $\blacktriangle \blacktriangledown$ para seleccionar.

Selección de vocal para los discos de Karaoke [DVD/Video CD]

1 Visualizar la pantalla AUDIO.

Presione AUDIO durante la reproducción.

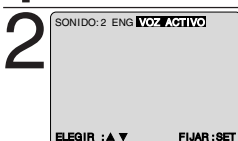

2 Seleccionar el ajuste deseado.

- 1) Presione $\blacktriangle \blacktriangledown$ (o $\blacktriangleleft \blacktriangleright$) para seleccionar.
- 2) Presione \blacktriangleright (o \blacktriangleleft) para ajustar. (DVD solamente)

- DVD Karaoke (1 vocal)
- DVD Karaoke (2 vocales)

VOCAL ON \leftrightarrow VOCAL OFF
 VOCAL V1 + V2 \rightarrow VOCAL V1
 VOCAL OFF \leftarrow VOCAL V2
 LR \rightarrow L \rightarrow R

- Video CD

Utilización de un menú de títulos [DVD solamente]

Algunos discos con películas, por ejemplo, vienen con dos o más títulos. Si el disco tiene un menú de títulos grabados, el botón TITLE podrá utilizarse para seleccionar el título de la película.

1 Presione TITLE durante la reproducción.

Ahora se visualiza una lista de los títulos del disco.

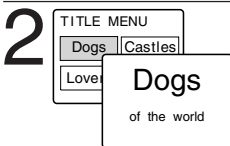

2 Seleccionar el título deseado.

- 1) Presione $\blacktriangle \blacktriangledown \blacktriangleleft \blacktriangleright$ o las teclas numéricas para seleccionar.
- 2) Presione SET o PLAY.

Utilización de un menú de DVD [DVD solamente]

Algunos discos DVD tienen estructuras únicas de menús llamadas menús DVD. Por ejemplo, los DVDs programados con un contenido complejo proporcionan menús guía, y los grabados con varios idiomas proporcionan menús para audio e idiomas de subtítulos. Aunque los contenidos de los menús DVD y la operación cambian de disco a disco, a continuación se explica la operación básica cuando se utiliza esta característica.

1 Presione MENU durante la reproducción.

El menú de DVD introducido en el disco se visualiza ahora.

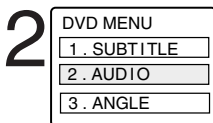

2 Seleccionar el ítem deseado.

- 1) Presione $\blacktriangle \blacktriangledown \blacktriangleleft \blacktriangleright$ o las teclas numéricas para seleccionar.
- 2) Presione SET o PLAY.

Ampliación de la imagen [DVD solamente]

Durante la reproducción de un DVD, puede ampliar partes específicas de una imagen y seleccionar la relación de zoom usando el botón ZOOM del control remoto.

Seleccione el tamaño de la imagen.

Presione ZOOM repetidamente para cambiar el tamaño de la imagen como se indica a continuación:

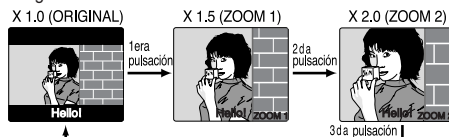

- Use los botones \blacktriangle y \blacktriangledown para desplazar la posición hacia arriba o hacia abajo.
- Use los botones \blacktriangleleft y \blacktriangleright para desplazar la posición hacia la izquierda o hacia la derecha.

Spanish Quick Use Guide/Guía para rápida consulta

Reproducción programada [Vídeo CD/CD]

Puede usted programar pistas específicas y el orden de reproducción.

• Vídeo CD o CD es insertado en el modo DVD.

1 Visualizar MAIN MENU.

Presione ACTION en el modo parada.



Visualizar la pantalla DVD.

- 1) Presione $\blacktriangle\blacktriangleright\blacktriangleleft$ para seleccionar "DVD."
- 2) Presione SET para visualizar.



Seleccionar "MODO DE REPRODUCCION."

- 1) Presione $\blacktriangle\blacktriangledown$ para seleccionar.
- 2) Presione SET para visualizar.



Seleccionar "REPRODUCCION DE PROGRAMAS."

- 1) Presione $\blacktriangle\blacktriangledown$ para seleccionar.
- 2) Presione SET para visualizar.



Seleccionar el número de la pista deseada. (Se visualizan los números de la pista del disco).

- 1) Presione $\blacktriangle\blacktriangleright\blacktriangleleft$ para seleccionar.
 - 2) Presione SET para seleccionar.
- Repita el paso 5 para seleccionar otra pista.
 - La pista seleccionada se añade a la parte derecha.



Comenzar "REPRODUCCION DE PROGRAMAS."

- 1) Presione $\blacktriangle\blacktriangleright\blacktriangleleft$ para seleccionar "INICIAR."
 - 2) Presione SET.
- La reproducción comienza en la secuencia programada.
 - Para cancelar, pulsar STOP durante la reproducción y luego presione CLEAR.

Fijaciones iniciales

1 Visualizar MAIN MENU. Presione ACTION en el modo de parada.

2 Visualizar la pantalla DVD. 1) Presione $\blacktriangle\blacktriangleright\blacktriangleleft$ para seleccionar. 2) Presione SET.

3 Seleccionar el artículo deseado. 1) Presione $\blacktriangle\blacktriangledown$ para seleccionar. 2) Presione SET.

IDIOMAS DEL DISCO

Todos los idiomas ofrecidos en el disco pueden ser ajustados. Si el idioma ajustado no es ofrecido en el disco, se seleccionará el idioma original del disco.

SALIDA DE AUDIO

Puede usted ajustar la salida audio procedente del terminal de salida audio digital.

DETENER RASTREO

Para seleccionar "CAMPO" o "CUADRO" para prevenir inestabilidad o para permitir ver textos pequeños o patrones finos claramente en el modo de imagen fija.

4 : 3 PREFERENCIA

Para seleccionar si el material del vídeo para pantalla ancha será vuelto a reproducir en el estilo Pan&Scan o en el estilo Letterbox en la pantalla.

4 Seleccionar el artículo deseado. 1) Presione $\blacktriangle\blacktriangledown$ para seleccionar. 2) Presione SET.

5 Volver a visualizar el menú de DVD para continuar el ajuste.

Presione ACTION y pase al paso 3 para ajustar otro ajuste o, para salir, presione ACTION tres veces.

Selección de IDIOMAS DEL DISCO [DVD solamente]

Seleccione "AUDIO" Inglés / Español / Francés :

(Fijación de fábrica : inglés)

Original : Se seleccionará el idioma original de cada disco.

OTRO ** :** Se puede seleccionar el otro idioma.

Seleccione "SUBTITULO"

AUTO : Se seleccionará el mismo que fue seleccionado en la preparación de "AUDIO". (Fijación de fábrica)

- Si el idioma seleccionado en la preparación de "AUDIO" se utiliza durante la reproducción, los subtítulos no aparecerán.
- Si se utiliza otro idioma durante la reproducción, los subtítulos aparecerán en el idioma seleccionado en la preparación de "AUDIO"

Inglés / Español / Francés

OTRO ** :** Se puede seleccionar el otro idioma.

Seleccione "MENU"

Inglés / Español / Francés : (Fijación de fábrica : inglés)

OTRO ** :** Se puede seleccionar el otro idioma.

Reproducción arbitraria [Vídeo CD/CD]

Las pistas se reproducen de forma arbitraria.

1 Repita los pasos 1-3 de la página anterior.



Seleccionar "REPRODUCCION ALEATORIA."

- 1) Presione $\blacktriangle\blacktriangledown$ para seleccionar.
 - 2) Presione SET.
- Comienza la reproducción arbitraria.
 - Para cancelar, presione STOP durante la reproducción y luego presione CLEAR.

Selección de SALIDA DE AUDIO

Seleccione "LPCM(DVD)"

INACTIVO : Por el conector de salida de audio digital solamente sale PCM lineal de 48 kHz/16 bits. Durante la reproducción del DVD grabado en el PCM lineal de 48 kHz/20 bits o 96 kHz, no sale audio digital. (Fijación de fábrica)

PCM : Durante la reproducción del DVD grabado en el PCM lineal de 48 kHz/20 bits/24 bits o 96 kHz, sale audio digital convertido a 48 kHz/16 bits. (La salida digital de audio PCM está restringida a 48 kHz/16bits o menos para proteger los derechos de autor.)

Seleccione "Dolby Digital"

Bitstream: Sale un flujo de bits Dolby digital (2ch-5.1ch). (Fijación de fábrica)

INACTIVO : No hay salida de audio.

Seleccione "dts"

Bitstream : Sale un flujo de bits dts. (Fijación de fábrica)

INACTIVO : No hay salida de audio.

Seleccione "DRC (Dynamic Range Compression)"

INACTIVO : Se selecciona el margen de audio normal. (Fijación de fábrica)

ACTIVO : Seleccione este ajuste para disfrutar de un sonido dinámico incluso a bajo volumen. Esto es muy útil para escuchar durante la noche. [Esta función sólo se activa con DVDs Dolby Digital.]

Seleccione "SURROUND"

El sonido envolvente crea el efecto de sonido que procede de altavoces que parecen estar en la parte de atrás aún cuando solo se ha conectado a un sistema estéreo de 2 canales.

INACTIVO : No efecto de sonido envolvente. (Fijación de fábrica)

ACTIVO : Efecto de sonido envolvente.

Selección de DETENER RASTREO

AUTO : Durante el modo de imagen fija se seleccionarán automáticamente "Campo fijo" o "Cuadro fijo" (Fijación de fábrica)

CAMPO : Seleccione este ajuste cuando ocurra "distorsión" en las imágenes, incluso cuando se haya seleccionado "AUTO".

CUADRO : "Cuadro fijo" es siempre seleccionado. Seleccione este ajuste cuando no se puedan ver claramente texto pequeño o patrones finos incluso cuando esté seleccionado "AUTO".

Selección de 4 : 3 PREFERENCIA

Pan&Scan : Datos de la pantalla ancha de vídeo son reproducidos en el estilo Pan & Scan (la parte derecha e izquierda de la pantalla son recortadas). (Fijación de fábrica)

- Datos de vídeo no formateados en Pan & Scan serán reproducidos en el estilo letterbox.

Letterbox : Datos de la pantalla ancha de vídeo son reproducidos en el estilo Letterbox (la parte de arriba y abajo de la pantalla tienen un margen negro).

Index

TV / VCR

- A** Accessories 4
 - AC Power Plug 10
 - ACTION button 8, 16
 - ADD / DLT button 8, 17
 - Audio Adjustment 47
 - Audio Auto Gain Control (AGC) 46
 - Audio button 8, 23
 - Audio connections 12
 - Audio Features 44, 45
 - Audio Menu 46
 - Audio Mode for FM Radio 29
 - Audio Mode for Playback 44
 - Audio Mode for Recording 44
 - Audio Mode for TV Viewing 23
 - Audio Mute 22
 - Audio / Video In Jack 10
 - Audio Output Connector (L/R) 11
 - Auto Operation Functions 37
- B** Batteries 4
 - Before Requesting Service 60, 61
 - Before Using 4
 - Blocking Message 43
 - Blue Screen Display 27
 - Broadcast Types 23
- C** Cable Box Brand Code Number 33
 - Cable Box Universal Remote
 - Control Feature 32
 - Cassette Compartment 10
 - Caption On Mute 25
 - Channel 16, 17, 27
 - Channel Caption 38
 - CHANNEL UP / DOWN button 8, 22
 - Clock 16, 17
 - Closed Caption 24, 25
 - CM SKIP / ZERO SEARCH button .. 8, 36, 37
 - Code Numbers, DSS / Cable Box Brand 32
 - Commercial Skip 37
 - Connections 11
 - Connections, Audio 12
 - Connections, DSS / Cable Box 11
 - Connections, Antenna/Cable 11
 - Copy Your Tapes (Dubbing) 19
 - COUNTER RESET button 8, 36
 - Customer Services Directory 33
- D** DISPLAY / ENTER button 8, 27, 32
 - DSS Brand Code Number 75
 - DSS CABLE button 8, 32
 - DSS / Cable Box Connections 11
 - DST (Daylight Saving Time) 6
- E** Eject button 8
 - Eject tape 18
- F** Fast Forward 18
 - FF button 8, 18
 - FM button 8, 28, 29
 - FM Radio 28, 29
 - Forward Search 18
 - Frame by Frame Advance 18
 - Front Panel Indicators 9
 - Function Display 27
- H** Head Cleaning 6
- I** Important Safeguards and Precautions 2
 - Information (Unit, Cassette, Disc) 6 - 7
 - Initial Setup 14
 - Index Search 34
 - Indicators on the Front Panel 9
 - Input Mode 19
- L** Language 16
 - LIGHT button 9
 - Limited Warranty BC
 - Location of Controls 8
- M** MTS Broadcast / TV Stereo System 23
 - MUTE button 8, 22
- N** NUMBER keys 8, 22
- O** 100 Key 22
 - One Touch Recording 18
 - On-Screen Display (OSD) 27
 - ON-TIMER with Alarm 26
- P** Phones 22
 - Playback 18
 - PLAY button 8, 18
 - POWER button 8, 14
 - PROG button 8, 26, 30
 - Program End Search 35
 - PROG TIMER Indicator 9, 30
- Q** Quality Picture 6
- R** Rapid Tune 22
 - R-TUNE button 8, 22
 - REC button 8, 18
 - REC Indicator 9, 18
 - Rec(ord) 18
 - Record / Playback Speed Settings 4
 - Remote Control Buttons 8
 - Remote Sensor 9
 - Remote Warning Feature 39
 - Repeat Play 36
 - Reset Language, Channels, Clock, Time Zone Adjust 16, 17
 - Reset unit 15
 - Reverse Search 18
 - REW button 8, 18
 - Rewind 18

TV / VCR

S Safety Precautions	3
SEARCH button	8, 34, 35
Secret Code	40
Selecting Input Mode	19
SELECT / SET button	8, 16
Sleep Timer	26
Slow Motion	18
Spanish Quick Use Guide	65
Special VCR Features	38
Specifications	6
SPEED button	8, 18
Still Picture	18
STILL / PAUSE button	8, 18
STOP button	8, 18
SURROUND button	8, 45
Surround Sound	45

T Table of Contents	5
Tape Erasure Prevention	4
Tape Operation	34
Timer Program Review, Replace, Clear ..	31
Timer Recording	30
Timer Recording Cancellation	31
Time Zone Adjust	17
TRACKING / V-LOCK buttons	6, 8
TV Operation	22
TV Timer Features	26
TV - VCR button	8, 32
TV/VCR Status & Clock Display	27
U Unit, Front/Rear view	10, 11
Universal Remote Control	32
US MOVIES Ratings	41
US TV PROGRAMS Ratings	42
V VCR Lock	39
Video Adjustment	47
Video Menu	46
V-Chip Control Feature	40
VHF / UHF Antenna Input Terminal	11
VOLUME UP / DOWN button	8, 22
W Warning and Instruction Displays	62
Weak Signal Display Feature	39
Z Zero Search	36

DVD

A ANGLE button	8, 49
Angle Indicator	9, 49
Auto-Power Off function	21
AUDIO button	8, 48
AUDIO OUTPUT	58
Audio soundtrack language (DVD)	48
B Basic DVD Operation	20
C CLEAR button	8, 51, 53
D Definition of terms	7
Disc Audio attribute 1 type, sampling frequency, bit No.	48
Disc format	7
Disc handling	7
Disc information screen	54
DISC LANGUAGES (DVD)	57
Disc Operation	10, 48
Disc Tray	7, 20
DISPLAY button	8, 53
DVD button	8, 20
DVD Lock Feature (DVD)	56
DVD Lock Ratings (DVD)	56
DVD menu (DVD)	50
DVD Operation using On-Screen	53
F FF button	8, 20
Forward/ Reverse Chapter/ Track skip ..	21
Frame by Frame picture (DVD/Video CD)	21
K Karaoke (DVD/Video CD)	49

L Language Code List	8, 63
M MENU button	50
Multiple angle viewing (DVD)	49
O OPEN / CLOSE button	8, 20
Optical digital audio output connector ..	11
P Picture Zoom (DVD)	49
Play	20
Playback control (Video CDs)	21
PLAY button	8, 20
Program Play (Video CD/CD)	50
Program Repeat Play (Video CD/CD)	51
R Random Play (Video CD/CD)	51
Region number	3
Forward / Reverse rapid scene search ..	21
Repeat Play	55
RESUME function	21
RETURN button	8, 20
REW button	8, 20
S Settings for DVD Operation	57
SKIP + / - button	8, 20
Slow Motion (DVD/Video CD)	21
SLOW + / - button	8, 21
STILL MODE	59
Still (Pause) Picture	21
STILL / PAUSE button	8, 21
Subtitle language (DVD)	48
T TV MODE	59
Title menu (DVD)	50
U Unit information screen (Unit)	55
Z Zoom button	8, 49

Limited Warranty

PANASONIC CONSUMER ELECTRONICS COMPANY,
DIVISION OF MATSUSHITA ELECTRIC
CORPORATION OF AMERICA
One Panasonic Way Secaucus, New Jersey 07094

PANASONIC SALES COMPANY, DIVISION OF MATSUSHITA
ELECTRIC OF PUERTO RICO, INC.,
AVE. 65 de Infantería, Km. 9.5 San Gabriel Industrial Park,
Carolina, Puerto Rico 00985

Panasonic/Quasar Video Products Limited Warranty

Limited Warranty Coverage

If your product does not work properly because of a defect in materials or workmanship, Panasonic Consumer Electronics Company or Panasonic Sales Company (collectively referred to as "the warrantor") will, for the length of the period indicated on the chart below, which starts with the date of original purchase ("warranty period"), at its option either (a) repair your product with new or refurbished parts, or (b) replace it with a new or a refurbished product. The decision to repair or replace will be made by the warrantor.

Product	Parts	Labor	Service	Contact Number
Camcorder	One (1) Year (except CCD Image Sensor) CCD Image Sensor - 6 (Six) Months	Ninety (90) Days Ninety (90) Days	Carry-In or Mail-In	1-800-211-PANA(7262)
DVD/VCR Deck, A/V Mixer	One (1) Year	Ninety (90) Days	Carry-In or Mail-In	1-800-211-PANA(7262)
TV/VCR, TV/DVD, TV/DVD/VCR Combination	One (1) Year (except CRT) CRT - Two (2) Years	Ninety (90) Days Ninety (90) Days	Carry-In: 21" CRT and Smaller In-Home or Carry-In: 22" CRT and Larger	1-800-211-PANA(7262)
TV/HDR Combination	One (1) Year (except CRT) CRT - Two (2) Years	Ninety (90) Days Ninety (90) Days	In-Home or Carry-In	1-888-843-9788
Rechargeable Batteries (in exchange for defective item)	Ten (10) Days	Not Applicable	Carry-In or Mail-In	1-800-211-PANA(7262)
Tape (in exchange for defective item)	Five (5) Days	Not Applicable	Carry-In or Mail-In	1-800-211-PANA(7262)
Memory Cards (in exchange for defective item)	Ninety (90) Days	Not Applicable	Carry-In or Mail-In	1-800-211-PANA(7262)

During the "Labor" warranty period there will be no charge for labor. During the "Parts" warranty period, there will be no charge for parts. You must carry-in or mail-in your product or arrange for in-home service, as applicable, during the warranty period.

If non-rechargeable batteries are included, they are not warranted. This warranty only applies to products purchased and serviced in the United States or Puerto Rico. This warranty is extended only to the original purchaser of a new product which was not sold "as is". A purchase receipt or other proof of the original purchase date is required for warranty service.

Carry-In, Mail-in or In-Home Service

For Carry-In, Mail-In or In-Home Service (as applicable) in the United States call toll free contact number listed above or visit Panasonic Web Site: <http://www.panasonic.com>

For assistance in Puerto Rico call Panasonic Sales Company (787)-750-4300 or fax (787)-768-2910.

In-Home service, if applicable, requires clear, complete and easy access to the product by the authorized servicer and does not include removal or re-installation of an installed product. It is possible that certain in-home repairs will not be completed in-home, but will require that the product, or parts of the product, be removed for shop diagnosis and/or repair and then returned.

Limited Warranty Limits And Exclusions

This warranty ONLY COVERS failures due to defects in materials or workmanship, and DOES NOT COVER normal wear and tear or cosmetic damage, nor does it cover markings or retained images on the picture tube resulting from viewing fixed images (including, among other things, letterbox pictures on standard 4:3 screen TV's, or non-expanded standard 4:3 pictures on wide screen TV's, or onscreen data in a stationary and fixed location). The warranty ALSO DOES NOT COVER damages which occurred in shipment, or failures which are caused by products not supplied by the warrantor, or failures which result from accidents, misuse, abuse, neglect, mishandling, misapplication, alteration, faulty installation, set-up adjustments, misadjustment of consumer controls, improper maintenance, power line surge, lightning damage, modification, or commercial use (such as in a hotel, office, restaurant, or other business), rental use of the product, service by anyone other than a Factory Servicenter or other Authorized Servicer, or damage that is attributable to acts of God.

THERE ARE NO EXPRESS WARRANTIES EXCEPT AS LISTED UNDER "LIMITED WARRANTY COVERAGE". THE WARRANTOR IS NOT LIABLE FOR INCIDENTAL OR CONSEQUENTIAL DAMAGES RESULTING FROM THE USE OF THIS PRODUCT, OR ARISING OUT OF ANY BREACH OF THIS WARRANTY. (As examples, this excludes damages for lost time, cost of having someone remove or re-install an installed unit if applicable, or travel to and from the servicer, loss of media or images, data or other memory or recorded content. The items listed are not exclusive, but are for illustration only.)

ALL EXPRESS AND IMPLIED WARRANTIES, INCLUDING THE WARRANTY OF MERCHANTABILITY, ARE LIMITED TO THE PERIOD OF THE LIMITED WARRANTY.

Some states do not allow the exclusion or limitation of incidental or consequential damages, or limitations on how long an implied warranty lasts, so the exclusions may not apply to you.

This warranty gives you specific legal rights and you may also have other rights which vary from state to state. If a problem with this product develops during or after the warranty period, you may contact your dealer or Servicenter. If the problem is not handled to your satisfaction, then write to the warrantor's Consumer Affairs Department at the addresses listed for the warrantor.

PARTS AND SERVICE (INCLUDING COST OF AN IN-HOME SERVICE CALL, WHERE APPLICABLE) WHICH ARE NOT COVERED BY THIS LIMITED WARRANTY ARE YOUR RESPONSIBILITY.

Customer Services Directory

*For Product Information, Operating Assistance, Literature Request, Dealer Locations, and all Customer Service inquiries please contact:
1-800-211-PANA (7262), Monday-Friday 9 am-9 pm; Saturday-Sunday 9 am-7 pm, EST.
or send e-mail : consumerproducts@panasonic.com*

*Web Site: <http://www.panasonic.com>
You can purchase parts, accessories or locate your nearest servicenter by visiting our Web Site.*

Accessory Purchases:

1-800-332-5368 (Customer Orders Only)
Panasonic Services Company 20421 84th Avenue South, Kent, WA 98032
(Monday-Friday 6 am-5 pm; Saturday 6 am-10:30 am, PST)
(Visa, MasterCard, Discover Card, American Express, Check)

Service in Puerto Rico

*Matsushita Electric of Puerto Rico, Inc. Panasonic Sales Company/ Factory Servicenter:
Ave. 65 de Infantería, Km. 9.5, San Gabriel Industrial Park, Carolina, Puerto Rico 00985
Phone (787)750-4300 Fax (787)768-2910*

LSQT0520A

Panasonic Consumer Electronics Company,
Division of Matsushita Electric Corporation of America
One Panasonic Way Secaucus, New Jersey 07094
Panasonic Sales Company ("PSC"),
Division of Matsushita Electric of Puerto Rico, Inc.
Ave. 65 de Infantería, Km. 9.5
San Gabriel Industrial Park, Carolina, Puerto Rico 00985



Printed in U.S.A
LSQT0520A
M0202-0